

Continental 
The Future in Motion



BICYCLE

Tire Range 2020-2021

conti-bicycletires.com

E-TIRES

SUITABLE FOR E-BIKES

For our E-Bike tire we fall back on over 100 years' experience with moped and motorcycle tires. All of our urban/tour tires are rated to a standard speed of at least 25 km/h. Those tires marked e50 are also certified for S-Pedelecs. With their high quality structure, puncture protection is high and the rolling resistance is low offering protection from premature wear brought about by the additional driving force.



Grand Prix 5000
30-622



NEW
SIZE



Ultra Sport III



NEW
DESIGN



CONTACT Urban



NEW



Terra Speed
Terra Trail



Top CONTACT Family



Top CONTACT
Top CONTACT Winter II Premium



Make it BIG!



Der Baron 2.6 Projekt
Trail King 2.6/2.8
Mountain King 2.6/2.8
Cross King 2.6/2.8



CONTACT Plus Family



CONTACT Plus
CONTACT Plus City



KING-Series



Trail King
Mountain King
Cross King
Race King

excluding RaceSport



CONTENT

20/21

Der Baron Projekt **10** Der Kaiser Projekt **10** Trail King **11** Der Baron **12** Der Kaiser **13** Mud King **13** Cross Mountain King **14**



Grand Prix 5000 TL **23** Grand Prix 5000 **23** Grand Prix Attack&Force III **24** Grand Prix TT **24** Grand Prix GT **24** Grand Prix **24**











Competition **30**
Podium TT **30**



CONTACT Urban **35** Grand Prix Urban **34** Top CONTACT **36** Urban Taraxagum **35** Top CONTACT Winter II **36** CONTACT Plus City **36** CONTACT Plus Travel **36** CONTACT Plus **37** CONTACT **38**



LEGEND ARTICLE LISTS

-  Available from quarter...
-  Safety Level
-  Handmade in Germany
-  Color/sidewall
-  E25 E-Bike up to 25 km/h
-  E50 E-Bike up to 50 km/h
-  TR Tubeless Ready
-  Dynamo compatible

GRAVEL 08

Terra Speed **08**

Terra Trail **09**



MOUNTAINBIKE 10

King **14**

Race King **15**

Speed King **15**

Double Fighter III **16**

Explorer **16**

Traffic II **16**

Vapor **16**

Gravity **17**

Town & Country **17**

Vertical **17**



CROSS 20

Cross King CX **20**

Race King CX **20**

Speed King CX **21**

Mountain King CX **21**



ROAD 22

Grand Prix Classic **25**

Gatorskin **26**

SuperSport Plus **26**

Grand Sport Extra/Race **27**

Prix Supersonic **25**

Grand Prix 4Season **26**

Ultra Sport III **26**

Gator Hardshell **27**

Hometrainer **29**



TUBULAR 30

Competition TT **31**

Sprinter **32**

Olympic II **32**

Tempo II **33**

Attack & Force Comp **31**

Gatorskin **31**

Giro **32**

Sonderklasse II **32**

Grand Prix 4000 S II Tub **33**



URBAN / TOUR 34

Speed **38**

CONTACT Cruiser **39**

RIDE Tour **40**

RIDE City **40**

RIDE Classic **41**

CONTACT Spike **38**

CONTACT Travel **39**

RIDE Cruiser **40**

Speed RIDE **40**

AT RIDE **41**



OTHER 44

TUBES **44**

TIRES & SIZES **46**

ACCESSORIES **48**

POS **50**

TECH SUPPORT **54**

MADE IN GERMANY **56**

NOVELTIES

**Terra Speed cream
Terra Trail Shieldwall**

Page 08-09

**Cross King
Bernstein Edition**

Page 14

**Race King
Bernstein Edition**

Page 15





Grand Prix 5000
- new size -

Page 23

Ultra Sport III

Page 26

Competition TT

Page 31

CONTACT Urban

Page 35

GRAVEL



Terra Speed | Terra Trail
**CHOOSE ALTER ROAD,
CHOOSE TERRA**

For your way off-road. For more comfort. For the adventure. Be it the long tour, or the shortcut on your way home. Made to get you over rough and smooth. covered as well.



NEW

Terra Speed

ProTecton - 3/180 TPI

E25 TR

Article	ETRTO	Dimension	Color/sidewall	g	PSI
0101719	35-584	650 X 35B	● foldable	350	44-73
Q2 0101720	35-584	650 X 35B	● foldable	360	44-73
0101717	40-584	650 X 40B	● foldable	400	44-73
Q2 0101718	40-584	650 X 40B	● foldable	400	44-73
0101693	35-622	700 X 35C	● foldable	375	44-73
Q2 0101700	35-622	700 X 35C	● foldable	375	44-73
0101694	40-622	700 X 40C	● foldable	420	44-73
Q2 0101702	40-622	700 X 40C	● foldable	420	44-73

Terra Trail

ProTecton - 3/180 TPI

E25 TR

Article	ETRTO	Dimension	Color/sidewall	g	PSI
0101715	40-584	650 X 40B	● foldable	430	44-73
0101697	40-622	700 X 40C	● foldable	460	44-73

NEW

PureGrip Compound - ShieldWall System - 3/180 TPI

E25 TR

Article	ETRTO	Dimension	Color/sidewall	g	PSI
Q4 0150509	47-584	650 X 47B	● foldable	450	36-65
Q4 0150503	35-622	700 X 35C	● foldable	380	44-73
Q4 0150507	40-622	700 X 40C	● foldable	440	44-73



MTB



Der Kaiser Projekt

THE EMPEROR'S RACING GEAR

Race tire with efficient propulsion, phenomenal braking power and precise handling on bends. The profile design derived directly from the toughest World Cup courses.



APEX PROTECTION^{APEX}



EX25

Der Baron Projekt

THE ENDURO BARON

Technical, versatile and sophisticated enduro tyre which is always the right choice. Versatile tread pattern with good rolling characteristics and a sporting weight.



PROTECTION^{APEX}



EX25



Trail King

SUPER PERFORMANCE ON EVERY TRAIL

This tire shines on enduro bikes and „all mountain“ bikes with a suspension travel of greater than 140 mm, thanks to its comfortable and voluminous casing. Multitude of small knobs guarantee best traction on any difficult trail. Excellent puncture resistance and maximum stability.



Der Kaiser Projekt

BlackChili Compound - Apex - 6/360 TPI

Article	ETRTO	Dimension	Color/sidewall	g	PSI
0101723	60-559	26 x 2.40	● Wire	1100	36-51
0101722	60-584	275 x 2.40	● Wire	1150	36-51
0101721	60-622	29 x 2.40	● Wire	1225	36-51

BlackChili Compound - ProTection Apex - 3/180 TPI

E25 TR

Article	ETRTO	Dimension	Color/sidewall	g	PSI
0101566	60-559	26 x 2.40	● foldable	945	36-51
0101567	60-584	275 x 2.40	● foldable	990	36-51
0101569	60-622	29 x 2.40	● foldable	1055	36-51

Der Baron Projekt

BlackChili Compound - ProTection Apex - 3/180 TPI

E25 TR

Article	ETRTO	Dimension	Color/sidewall	g	PSI
0101570	60-559	26 x 2.40	● foldable	890	36-51
0101572	60-584	275 x 2.40	● foldable	925	36-51
0101381	65-584	275 x 2.60	● foldable	935	29-44
0101573	60-622	29 x 2.40	● foldable	995	36-51

Trail King

BlackChili Compound - ProTection Apex - 3/180 TPI

E25 TR

Article	ETRTO	Dimension	Color/sidewall	g	PSI
0101487	55-559	26 x 2.20	● foldable	755	45-58
0101478	60-559	26 x 2.40	● foldable	850	36-51
0101468	55-584	275 x 2.20	● foldable	795	45-58
0101460	60-584	275 x 2.40	● foldable	890	36-51
0101382	65-584	275 x 2.60	● foldable	980	29-44
0101383	70-584	275 x 2.80	● foldable	1030	25-40
0101476	55-622	29 x 2.20	● foldable	845	45-58
0101477	60-622	29 x 2.40	● foldable	945	36-51

PureGrip Compound - ShieldWall System - 3/180 TPI

E25 TR

Article	ETRTO	Dimension	Color/sidewall	g	PSI
0150305	55-559	26 x 2.20	● foldable	715	45-58
0150300	60-559	26 x 2.40	● foldable	835	36-51
0150293	55-584	275 x 2.20	● foldable	760	45-58
0150288	60-584	275 x 2.40	● foldable	880	36-51
0150332	65-584	275 x 2.60	● foldable	980	29-44
0150331	70-584	275 x 2.80	● foldable	1055	25-40
0150298	55-622	29 x 2.20	● foldable	805	45-58
0150299	60-622	29 x 2.40	● foldable	935	36-51
Q2 0150499	65-622	29 x 2.60	● foldable	995	29-44

Wire - 3/180 TPI

E25

Article	ETRTO	Dimension	Color/sidewall	g	PSI
0150414	60-559	26 x 2.40	● Wire	840	36-51
0150416	60-584	275 x 2.40	● Wire	885	36-51
0150419	60-622	29 x 2.40	● Wire	940	36-51

“Continental’s Trail King tires deliver an impressively predictable ride.”

PINKBIKE REVIEWS 02/19

**NEW
SIZE**



Der Baron

DURABLE ALL-ROUNDER FOR THE BIKE PARK

The universal freeride tire offering massive tread blocks and durability. Uniform profile design for best traction on all surfaces.



APEX



Der Baron

BlackChili Compound - Apex - 6/360 TPI

Article	ETRTO	Dimension	Color/sidewall	g	PSI
0100227	62-559	26 x 2.50	● Wire	1235	45-58

Der Kaiser

BlackChili Compound - Apex - 6/360 TPI

Article	ETRTO	Dimension	Color/sidewall	g	PSI
0100226	62-559	26 x 2.50	● Wire	1205	45-58

Mud King

BlackChili Compound - ProTection - 3/180 TPI

TR

Article	ETRTO	Dimension	Color/sidewall	g	PSI
0100547	47-559	26 x 1.80	● foldable	505	45-65
0101084	47-584	27.5 x 1.80	● foldable	530	45-65
0100918	47-622	29 x 1.80	● foldable	565	45-65

BlackChili Compound - Apex - 6/360 TPI

Article	ETRTO	Dimension	Color/sidewall	g	PSI
0100414	57-559	26 x 2.30	● Wire	1085	45-65
0100901	57-584	27.5 x 2.30	● Wire	1140	45-65
0101083	57-622	29 x 2.30	● Wire	1215	45-65

Der Kaiser**THE HIGH POINT FOR DOWNHILLERS**

An adaptable downhill tire which grips any terrain in search for the fastest time. Good rolling and durable profile with clearly defined central and outer knobs.

**APEX****Mud King****AT HOME IN THE MUD**

For deep, muddy conditions with a narrow casing for adequate frame clearance. Knobbly tread for optimum braking and steering, even under the most difficult conditions.

**APEX**



Mountain King FOR SAFE OFF-ROADING

The perfect trail ride companion - not stingy on grip, ideal for full-suspension trail bikes. The snappy central knobs and grippy outer knobs means it offers maximum grip.



Cross King | Cross King Bernstein Edition THE ALL-ROUNDER

Versatile competition and trail tire, sure footed in turns and comfortable. Good grip and available with various technologies. Smoothly rolling tire that adapts to any terrain with its special tread.



Mountain King						
BlackChili Compound - ProTecton - 3/180 TPI E25 TR						
Article	ETRTO	Dimension	Color/sidewall	g	PSI	
0101479	58-559	26 x 2.30	● foldable	690	40-54	
0101461	58-584	27.5 x 2.30	● foldable	725	40-54	
0101583	65-584	27.5 x 2.60	● foldable	805	29-44	
0101582	70-584	27.5 x 2.80	● foldable	840	25-40	
0101469	58-622	29 x 2.30	● foldable	770	40-54	
PureGrip Compound - ShieldWall System - 3/180 TPI E25 TR						
Article	ETRTO	Dimension	Color/sidewall	g	PSI	
0150301	58-559	26 x 2.30	● foldable	725	40-54	
0150289	58-584	27.5 x 2.30	● foldable	770	40-54	
0150335	65-584	27.5 x 2.60	● foldable	935	29-44	
0150334	70-584	27.5 x 2.80	● foldable	1020	25-40	
0150294	58-622	29 x 2.30	● foldable	815	40-54	
Wire - 3/180 TPI E25						
Article	ETRTO	Dimension	Color/sidewall	g	PSI	
0150424	58-559	26 x 2.30	● Wire	720	40-54	
0150425	58-584	27.5 x 2.30	● Wire	765	40-54	
0150427	58-622	29 x 2.30	● Wire	810	40-54	

Cross King						
BlackChili Compound - RaceSport - 3/180 TPI						
Article	ETRTO	Dimension	Color/sidewall	g	PSI	
0101482	55-559	26 x 2.20	● foldable	505	45-58	
0101480	58-559	26 x 2.30	● foldable	605	40-54	
0101464	55-584	27.5 x 2.20	● foldable	530	45-58	
0101689	55-584	27.5 x 2.20	● foldable	555	45-58	
0101462	58-584	27.5 x 2.30	● foldable	635	40-54	
0101690	55-622	29 x 2.20	● foldable	585	45-58	
0101470	55-622	29 x 2.20	● foldable	565	45-58	
0101474	58-622	29 x 2.30	● foldable	675	40-54	

Cross King						
BlackChili Compound - ProTecton - 3/180 TPI E25 TR						
Article	ETRTO	Dimension	Color/sidewall	g	PSI	
0101483	55-559	26 x 2.20	● foldable	585	45-58	
0101481	58-559	26 x 2.30	● foldable	690	40-54	
0101465	55-584	27.5 x 2.20	● foldable	615	45-58	
0101463	58-584	27.5 x 2.30	● foldable	725	40-54	
0101384	65-584	27.5 x 2.60	● foldable	805	29-44	
0101385	70-584	27.5 x 2.80	● foldable	840	25-40	
0101471	55-622	29 x 2.20	● foldable	655	45-58	
0101475	58-622	29 x 2.30	● foldable	770	40-54	
PureGrip Compound - ShieldWall System - 3/180 TPI E25 TR						
Article	ETRTO	Dimension	Color/sidewall	g	PSI	
0150310	50-559	26 x 2.00	● foldable	625	50-65	
0150303	55-559	26 x 2.20	● foldable	695	45-58	
0150302	58-559	26 x 2.30	● foldable	725	40-54	
0150308	50-584	27.5 x 2.00	● foldable	665	50-65	
0150291	55-584	27.5 x 2.20	● foldable	740	45-58	
0150290	58-584	27.5 x 2.30	● foldable	780	40-54	
0150337	65-584	27.5 x 2.60	● foldable	920	29-44	
0150336	70-584	27.5 x 2.80	● foldable	1040	25-40	
0150306	50-622	29 x 2.00	● foldable	705	50-65	
0150295	55-622	29 x 2.20	● foldable	785	45-58	
0150297	58-622	29 x 2.30	● foldable	825	40-54	
Q2 0150502	65-622	29 x 2.60	● foldable	995	29-44	
Wire - 3/180 TPI E25						
Article	ETRTO	Dimension	Color/sidewall	g	PSI	
0101687	50-406	20 x 2.00	● Wire	460	50-65	
0101688	50-507	24 x 2.00	● Wire	565	50-65	
0150399	50-559	26 x 2.00	● Wire	640	50-65	
0150404	55-559	26 x 2.20	● Wire	695	45-58	
0150407	58-559	26 x 2.30	● Wire	720	40-54	
0150402	50-584	27.5 x 2.00	● Wire	675	50-65	
0150405	55-584	27.5 x 2.20	● Wire	740	45-58	



Race King | Race King Bernstein Edition
FIRST CHOICE FOR RACERS

Classic competition tire which feels at home at the Cross Country World Cup or at marathons. Low rolling resistance, good self-damping and low weight make it the right choice for all race bikes.



Speed King
ROLLING CHARACTERISTICS TUNED AND TWEAKED

Tuning tire for racing bikes and carbon hardtails with minimum weight. Its propulsion-oriented profile geometry for minimal rolling resistance. Uncompromisingly fast and World Cup-trialed RaceSport casing.



Cross King						
Wire - 3/180 TPI						E25
0150408	58-584	27.5 x 2.30	● Wire	775	40-54	
0150403	50-622	29 x 2.00	● Wire	720	50-65	
0150406	55-622	29 x 2.20	● Wire	785	45-58	
0150410	58-622	29 x 2.30	● Wire	820	40-54	

Race King						
BlackChili Compound - RaceSport - 3/180 TPI						
Article	ETRTO	Dimension	Color/sidewall	g	PSI	
0101485	55-559	26 x 2.20	● foldable	465	45-58	
0101691	55-584	27.5 x 2.20	● foldable	525	45-58	
0101466	55-584	27.5 x 2.20	● foldable	495	45-58	
0101692	55-622	29 x 2.20	● foldable	555	45-58	
0101472	55-622	29 x 2.20	● foldable	525	45-58	

Race King						
BlackChili Compound - ProTecton - 3/180 TPI						
Article	ETRTO	Dimension	Color/sidewall	g	PSI	E25 TR
0101486	55-559	26 x 2.20	● foldable	555	45-58	
0101467	55-584	27.5 x 2.20	● foldable	580	45-58	
0101473	55-622	29 x 2.20	● foldable	615	45-58	

Race King						
PureGrip Compound - ShieldWall System - 3/180 TPI						
Article	ETRTO	Dimension	Color/sidewall	g	PSI	E25 TR
0150311	50-559	26 x 2.00	● foldable	590	50-65	
0150304	55-559	26 x 2.20	● foldable	660	45-58	
0150309	50-584	26 x 2.00	● foldable	625	50-65	
0150292	55-584	27.5 x 2.20	● foldable	695	45-58	
0150307	50-622	29 x 2.00	● foldable	660	50-65	
0150296	55-622	29 x 2.20	● foldable	740	45-58	

Race King						
Wire - 3/180 TPI						E25
0150433	55-584	27.5 x 2.20	● Wire	705	45-58	
Q2 0150446	50-622	29 x 2.00	● Wire refl.	680	50-65	
0150431	50-622	29 x 2.00	● Wire	675	50-65	
Q2 0150527	55-622	29 x 2.20	● Wire refl.	760	45-58	
0150435	55-622	29 x 2.20	● Wire	750	45-58	

Speed King						
BlackChili Compound - RaceSport - 3/180 TPI						
Article	ETRTO	Dimension	Color/sidewall	g	PSI	
0100728	55-559	26 x 2.20	● foldable	410	50-65	
0101110	55-584	27.5 x 2.20	● foldable	425	50-65	
0100933	55-622	29 x 2.20	● foldable	450	50-65	

DoubleFighter III						
3/180 TPI						
Article	ETRTO	Dimension	Color/sidewall	g	PSI	
0101282	47-305	16 x 1.75	● Wire refl.	380	50-65	
0101232	47-305	16 x 1.75	● Wire	380	50-65	
0101283	47-406	20 x 1.75	● Wire refl.	520	50-65	
0101233	47-406	20 x 1.75	● Wire	520	50-65	
0101284	47-507	24 x 1.75	● Wire refl.	620	50-65	
0101234	47-507	24 x 1.75	● Wire	620	50-65	
0101285	50-507	24 x 2.0	● Wire refl.	650	50-65	
0101251	50-507	24 x 2.0	● Wire	650	50-65	
0101235	50-559	26 x 1.90	● Wire	790	50-65	
0101286	50-559	26 x 1.90	● Wire refl.	790	50-65	
0101237	50-584	27.5 x 2.00	● Wire	860	50-65	
0101287	50-584	27.5 x 2.00	● Wire refl.	860	50-65	
0100795	37-622	700 x 35C	● Wire	550	58-85	
0101289	37-622	700 x 35C	● Wire refl.	550	58-85	
0101239	50-622	29 x 2.00	● Wire	915	50-65	
0101292	50-622	29 x 2.00	● Wire refl.	915	50-65	



DoubleFighter III
AN URBAN ADVENTURER WITH REAL VERSATILITY

The 'double': light rolling and quiet on tarmac, yet grips on tracks and gravel roads. Robust rubber sidewalls make it impervious to damage even over rough ground. The ideal tire for transforming an off road bike to a nippy city racer.

Explorer
THE CLASSIC MOUNTAINBIKE TIRES

Genuine all-round player who has proven itself over the years in all sorts of offroad adventures. Comfortable handling, reliable puncture protection and dynamic tread designs set this tire apart for smaller budgets.

The MTB Classics are back!



Traffic II
RELIABLE RIDING IN THE URBAN JUNGLE

Specially developed for daily use of the MTB in town and in the countryside. Thanks to a tough design and robust sidewalls it is a fearless companion in traffic.

Vapor
THE MARATHON SPECIALIST

Classic marathon tire. Easy handling, durable casing and long-lasting tread for sporty amateur rides.



Gravity MAKES RIDING ALL TRAILS FUN

A classic all rounder tire, offering very high level of comfort. The durable casing and long-lasting tread designed for sporty amateur riders.

Town & Country YOUR FRIEND AND AID

A reliable and fail-safe everyday tire. A loyal companion for sporty leisure riders.



Vertical THE MODERN CLASSIC

The original, do it all' MTB tire. Universal, knobby tread design for optimum grip on any terrain and durable casing and long-lasting tread for sporty amateur riders.

Explorer

3/84 TPI

Article	ETRTO	Dimension	Color/sidewall	g	PSI
0102501	47-305	16 x 1.75	● Wire	435	50-65
0105501	47-406	20 x 1.75	● Wire	555	50-65
0109002	47-507	24 x 1.75	● Wire	680	50-65
0115715	54-559	26 x 2.10	● Wire	620	50-65

Gravity

3/84 TPI

Article	ETRTO	Dimension	Color/sidewall	g	PSI
0116017	57-559	26 x 2.30	● Wire	795	50-65

Town&Country

3/84 TPI

Article	ETRTO	Dimension	Color/sidewall	g	PSI
0122294	47-559	26 x 1.90	● Wire	660	50-65
0115800	54-559	26 x 2.10	● Wire	740	50-65

Traffic II

3/84 TPI

Article	ETRTO	Dimension	Color/sidewall	g	PSI
0100352	47-507	24 x 1.75	● Wire refl.	735	45-58
0100205	50-559	26 x 1.90	● Wire	830	50-65
0100206	50-559	26 x 1.90	● Wire refl.	830	50-65
0100207	54-559	26 x 2.10	● Wire	915	50-65
0100208	54-559	26 x 2.10	● Wire refl.	915	50-65

Vapor

3/84 TPI

Article	ETRTO	Dimension	Color/sidewall	g	PSI
0115854	54-559	26 x 2.10	● Wire	710	50-65

Vertical

3/84 TPI

Article	ETRTO	Dimension	Color/sidewall	g	PSI
0116008	57-559	26 x 2.30	● Wire	755	50-65

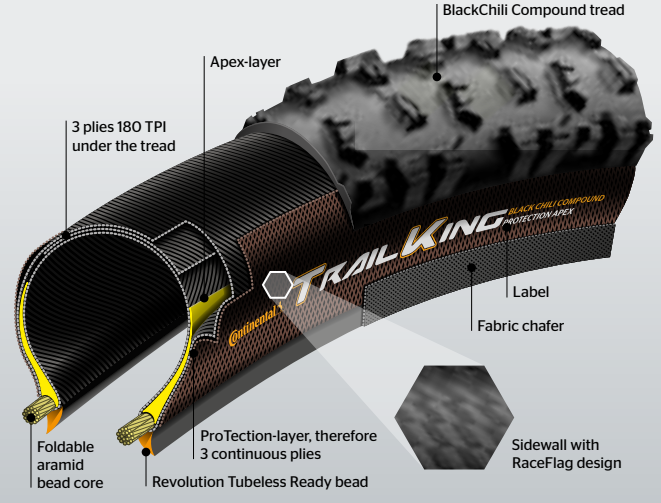

**Apex
FROM THE CAR TO THE BIKE**

Successfully used in car tires for years, its transition for use in our bicycle tires was only a matter of time. Apex stabilises the tire in turns and is a technology that also makes sense for high-volume bicycle tires. A natural rubber profile, set between the carcass layers at the base of the tire. Stiffens the sidewalls, there by minimizing the twisting of the tire by the high transverse loads. Stiffer sidewalls that in turn, reduce the risk of punctures and impede the tire from slipping off the rim. Destined for Downhill, Gravity Enduro and Freeride. Low pressure, enhanced grip is made possible without becoming too slack in corners. The risk of punctures decreases significantly.

**ProTecton Apex
CHALLENGES NEED TO BE MASTERED**

The ProTecton layer prevents cuts and punctures without any significant increase in weight. An extra Apex sidewall protects the tire from impact punctures even at low pressures. BlackChili Compound gives added grip.



**ProTecton
THE ROUGH WAY**

The extra all-round puncture protection layer renders the casings extremely durable and resistant to damage or penetration from foreign elements. Treads and sidewalls are equally protected, and are 25 % lighter and offer 30 % more puncture protection than their predecessors protected by DuraSkin®. Rolling resistance and absorption has also significantly improved. The new Revolution Tubeless Ready Bead improves the installation of Tubeless Ready Tires. For tubeless sealing we recommend the use of Continental RevoSealant.

**RaceSport
LIGHT, FAST, SAFE**

Developed together with professional mountain bikers, the RaceSport carcass unites light-weight construction with noticeably improved puncture protection for the perfect competition choice. Light: contains a particularly fine, flexible nylon fabric with an elaborately produced protective rubber coating. Fast and reliable: World Cup quality, low rolling resistance and puncture protection. Combined with our legendary BlackChili Compound, the right combination for XC and Marathon racing.





ShieldWall System
TUBELESS READY AND PUNCTURE PROTECTION FOR RIDERS ON A BUDGET

The ShieldWall system combines the optimum combination of high puncture protection and the low rolling resistance with low weight. This is made possible by an additional, all-round puncture protection layer, which consists of a finely woven cross fabric. This gives the tire a high resistance to punctures and damage. Despite its additional ply, the tire has a very good damping property and a high degree of flexibility to adapt perfectly to the ground. The revolutionary tubeless ready bead allows easy and uncomplicated mounting of the tire. For best results in sealing and in use, we recommend the use of the new Continental RevoSealant sealant.



Wire
RELIABLE QUALITY

The durable and adhesive rubber compound promises long riding pleasure. A sturdy 60 TPI nylon carcass ensures best durability. A strong wire core ensures firm hold on the rim. For ambitious amateur athletes an affordable alternative to our BlackChili and PureGrip tires.



Tubeless Ready Set
TUBELESS READY? NO PROBLEM!

Tubeless Ready tires can be used with or without tubes because the tire and rim are designed to seal directly to each other.

Specially designed for the mountain bike sector, an additional all-round puncture protection layer makes our carcasses particularly resistant and insensitive to damage and the penetration of foreign bodies. For maximum effect, we combine ProTecton with BlackChili Compound. The result: Versatile, lightweight and attractive tires. All tires with this technology can all be run Tubeless Ready.

We recommend Continental Tubeless Ready for all MTB tires with ProTecton, ProTecton Apex and ShieldWall Technology.



Tubeless Ready Set

Set contains*:

- 1x Conti RevoSealant 240 ml**
- 1x Tubeless rim tape**
- 2x Tubeless S42 valves**
- 3x Tire levers**
- 3x Mounting pads**
- 1x Mounting instruction**

Article	Sizes
0140092	25 mm
0140093	27 mm
0140094	29 mm

*all set articles are available separate

CROSS



Cross King CX

THE EXPERT FOR TOURING AND COMPETITION

A high performing all-rounder suitable for different terrain. Smooth running and fast rolling from the evenly distributed central tread, a lot of grip in turns from the pronounced outer lugs. The carcass width of 32 mm complies with UCI rules.



Race King CX

OUR FLOW GUARANTEE FOR OFFROAD RIDING

Outstanding for use on smoother terrain such as forest tracks and hillside paths. Technically manufactured with an optimal ratio of grip, ability to adapt to the terrain and low rolling resistance. Breathtaking rides guaranteed!



Cross King CX

BlackChili Compound - RaceSport - 3/180 TPI					
Article	ETRTO	Dimension	Color/sidewall	g	PSI
0100451	32-622	700 x 32C	● foldable	300	45-85
PureGrip Compound - NyTech Breaker - 3/180 TPI					
Article	ETRTO	Dimension	Color/sidewall	g	PSI
0150281	35-622	700 x 35C	● foldable	420	36-85

Race King CX

PureGrip Compound - NyTech Breaker - 3/180 TPI					
Article	ETRTO	Dimension	Color/sidewall	g	PSI
0150280	35-622	700 x 35C	● foldable	420	36-85

Speed King CX

BlackChili Compound - RaceSport - 3/180 TPI					
Article	ETRTO	Dimension	Color/sidewall	g	PSI
0101256	32-622	700 x 32C	● foldable	290	45-85
PureGrip Compound - NyTech Breaker - 3/180 TPI					
Article	ETRTO	Dimension	Color/sidewall	g	PSI
0150279	35-622	700 x 35C	● foldable	440	36-85

Mountain King CX

BlackChili Compound - RaceSport - 3/180 TPI					
Article	ETRTO	Dimension	Color/sidewall	g	PSI
0100472	32-622	700 x 32C	● foldable	300	45-85
PureGrip Compound - NyTech Breaker - 3/180 TPI					
Article	ETRTO	Dimension	Color/sidewall	g	PSI
0150282	35-622	700 x 35C	● foldable	420	36-85

Speed King CX THE TUNING CYCLOCROSS TIRE

The tire designed for racing over solid, dry or frozen terrain. A fast, scaly central tread design. Suitable for the heat of competition and as a commuter/tourer. The carcass width of 32 mm complies with UCI rules.



Mountain King CX SURE FOOTED, EVEN IN MUDDY TERRAIN

Mud specialist with maximal grip giving racers a decisive advantage. The well spaced lugs ensure good self-cleansing. The carcass width of 32 mm complies with UCI rules.



ROAD



[Grand Prix 5000]

“Magic Rubber”

TOUR 02/19

[Grand Prix 5000]

“Test Winner”

ROAD BIKE 04/19 | TOUR 07/2019



Grand Prix 5000 / Grand Prix 5000 TL THE NEW ERA IN CYCLING

The best allrounder in the field, brought to a whole new performance level. Ride faster, more comfortable, and with increased puncture protection. Made to make you better. If your aim is a tubeless approach, we've got you covered as well.



TL



Grand Prix 5000 vs. Grand Prix 4000S II

 **+12%**
better rolling resistance

 **+20%**
puncture protection

 **-10 g**
lighter [25-622]

 improved comfort

Grand Prix 5000

BlackChili Compound - Vectran Breaker - LazerGrip - ACT - 3/330 TPI					
Article	ETRTO	Dimension	Color/sidewall	g	PSI
0101620	25-584	650 x 25B	● foldable	205	95-120
0101622	28-584	650 x 28B	● foldable	235	95-116
0101623	23-622	700 x 23C	● foldable	200	110-120
0101624	25-622	700 x 25C	● foldable	215	95-120
0101625	28-622	700 x 28C	● foldable	235	95-116
0101626	32-622	700 x 32C	● foldable	290	85-102

BlackChili Compound - Vectran Breaker - LazerGrip - ACT - 3/330 TPI					
Article	ETRTO	Dimension	Color/sidewall	g	PSI
03 0101813	30-622	700 x 30C	● foldable	260	85-102

NEW SIZE

Grand Prix 5000 Tubeless

BlackChili Compound - Vectran Breaker - LazerGrip - ACT - 3/180 TPI					
Article	ETRTO	Dimension	Color/sidewall	g	PSI
0101627	28-584	650 x 28B	● foldable	300	65-94
0101628	25-622	700 x 25C	● foldable	300	80-109
0101629	28-622	700 x 28C	● foldable	320	65-94
0101630	32-622	700 x 32C	● foldable	370	65-87



Active Comfort Technology

The revolutionary approach in cycling. Embedded in the tire construction the Active Comfort Technology absorbs vibrations and smoothens your ride.



Lazer Grip

To make you one with the road. The lazered micro profile structure expands over the tire's shoulder and provides out-standing cornering.

[Grand Prix 5000 TL]

"Tip Puncture Resistance"

ROAD BIKE 06/19

BIKE
RUMOR!
2018
EDITOR'S
CHOICE



**Set Grand Prix Attack & Force III
THE AERO TUNING SET FOR THE ROAD**

Attack on the bike: much aero, low weight. The specially developed 3D tread pattern provides flow optimized behaviour. Front: agile and direct. Rear: comfortable and dampening.



**Grand Prix TT
TIME TRIAL: CHALLENGE THE CLOCK**

Super fast semi-slick tread pattern for racing against the clock on TT's and in triathlon. **!Optimized-rolling-resistance competition tire with reduced mileage and puncture protection.**



**Grand Prix GT
TRAINING PARTNER FOR THE GRAND TOUR**

Reliable tour and training partner for gran fondos and grand tours, even on the roughest roads. Solid handling in every situation.

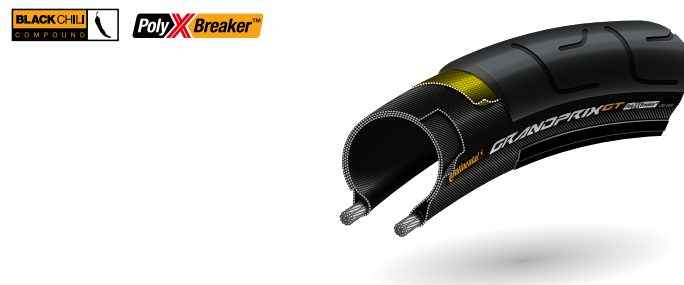

**Grand Prix
A COMFORTABLE ALL-ROUNDER THAT HAS BEEN WRITTEN INTO CYCLING HISTORY**

A reliable all-round tire with solid construction, made for sportive tours in demanding terrain. Made to last for many miles. Available in many sizes.

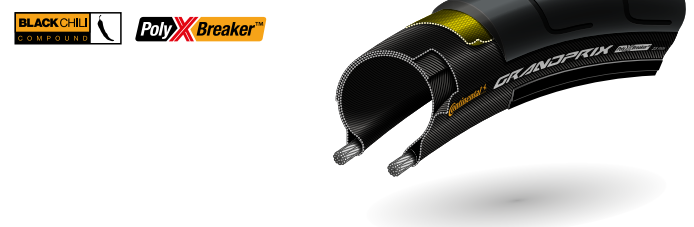



Grand Prix Supersonic THE NO COMPROMISE TIRE, MADE FOR COMPETITION

Simple efficient, time trial and cycling track specialists profit from its outstanding rolling characteristics. ! Tire purely for competitions with reduced mileage, without extra puncture protection.



Grand Prix Classic TECHNOLOGY OF TODAY COMBINED WITH AN OLD CLASSIC

The perfect match for the retro styled racing bike. Features with brown sidewalls and the original Conti Sport tread pattern from 1982.



Set Grand Prix Attack & Force III

BlackChili Compound - Vectran Breaker - 3/330 TPI

Article	ETRTO	Dimension	Color/sidewall	g	PSI
0101440	23-25-622	700 x 23/25C	● foldable	375	110-120

Grand Prix Attack III

BlackChili Compound - Vectran Breaker - 3/330 TPI

Article	ETRTO	Dimension	Color/sidewall	g	PSI
0101303	23-622	700 x 23C	● foldable	175	110-120

Grand Prix Force III

BlackChili Compound - Vectran Breaker - 3/330 TPI

Article	ETRTO	Dimension	Color/sidewall	g	PSI
0101304	25-622	700 x 25C	● foldable	200	95-120

Grand Prix TT

BlackChili Compound - Vectran Breaker - 3/330 TPI

Article	ETRTO	Dimension	Color/sidewall	g	PSI
0100487	23-622	700 x 23C	● foldable	170	110-120
0101077	25-622	700 x 25C	● foldable	190	95-120

Grand Prix Supersonic

BlackChili Compound - Supersonic - 3/330 TPI

Article	ETRTO	Dimension	Color/sidewall	g	PSI
0101079	20-622	700 x 20C	● foldable	140	145-170
0101080	23-622	700 x 23C	● foldable	155	115-145

Grand Prix GT

BlackChili Compound - PolyX Breaker - 3/180 TPI

Article	ETRTO	Dimension	Color/sidewall	g	PSI
0100464	25-622	700 x 25C	● foldable	280	110-120
0101096	28-622	700 x 28C	● foldable	315	95-116

Grand Prix

BlackChili Compound - PolyX Breaker - 3/180 TPI

Article	ETRTO	Dimension	Color/sidewall	g	PSI
0100149	28-559	26 x 1½	● foldable	245	95-116
0100506	23-622	700 x 23C	● foldable	225	110-120
0100637	25-622	700 x 25C	● foldable	230	110-120
0101109	28-622	700 x 28C	● foldable	270	95-116
0100148	28-559	26 x 1½	● Wire	310	95-116
0100502	23-571	650 x 23C	● Wire	280	110-120
0100505	23-622	700 x 23C	● Wire	295	110-120
0100636	25-622	700 x 25C	● Wire	305	110-120
0100157	28-622	700 x 28C	● Wire	340	95-116

Grand Prix Classic

BlackChili Compound - PolyX Breaker - 3/180 TPI

Article	ETRTO	Dimension	Color/sidewall	g	PSI
0100456	25-622	700 x 25C	● foldable	225	95-120

Grand Prix 4-Season

Double Vectran Breaker - 3/330 TPI

Article	ETRTO	Dimension	Color/sidewall	g	PSI
0100173	23-622	700 x 23C	● foldable	230	110-120
0100175	25-622	700 x 25C	● foldable	230	95-120
0101105	28-622	700 x 28C	● foldable	295	95-116
0101095	32-622	700 x 32C	● foldable	340	85-102

Grand Prix 4-Season Black Edition

Double Vectran Breaker - 3/330 TPI

Article	ETRTO	Dimension	Color/sidewall	g	PSI
0101441	23-622	700 x 23C	● foldable	230	110-120
0101442	25-622	700 x 25C	● foldable	230	95-120
0101443	28-622	700 x 28C	● foldable	295	95-116
0101444	32-622	700 x 32C	● foldable	340	85-102



Grand Prix 4-Season
THE ALL-YEAR-ROUND TIRE AND A RELIABLE COMPANION FOR THOSE HIGH MILEAGE ROAD CYCLISTS

Reliable companion for training rides and in competition, come rain or shine. The tire with a superior durability ready for any season. With DuraSkin® sidewall reinforcement (comes in black with our Black Edition).



Gatorskin
RIDE HOW AND WHERE YOU WANT: THE GLOBAL NUMBER ONE FOR FIXED, MESSENGER AND URBAN CYCLISTS

The right tire when it comes to tough conditions. The right choice for a strong performance in the urban field and on tour. With DuraSkin® sidewall reinforcement (comes in black with our Black Edition).



NEW DESIGN



Ultra Sport III
MODERN TIRE FOR THOSE NEW TO ROAD CYCLING

Completely renewed, sporting a dynamic tread pattern design. Matches with a race bike, as well as a classic city road bike. Available in a wide range of dimensions and colors.

PURE GRIP
COMPOUND



Super Sport Plus
FIXIE OR RACING BIKE? SUPER FAST AND SUPER RELIABLE FROM A TO B

Fast on tarmac and bicycle paths with its special slick tread pattern. Longevity and high puncture protection are the main focus. A reliable companion also for newcomers to cycling.

Plus+





Black Edition

Gatorskin

PolyX Breaker - 3/180 TPI

Article	ETRTO	Dimension	Color/sidewall	g	PSI
0118365	28-559	26 x 1¼	● Wire	320	95-120
0118364	23-571	650 x 23C	● Wire	270	110-120
0118537	23-622	700 x 23C	● Wire	290	110-120
0118539	25-622	700 x 25C	● Wire	310	95-120
0121228	28-622	700 x 28C	● Wire	360	95-116
0100437	32-622	700 x 32C	● Wire	420	85-102
0122300	32-630	27 x 1¼	● Wire	420	85-102
0118538	23-622	700 x 23C	● foldable	220	110-120
0100084	25-622	700 x 25C	● foldable	240	95-120
0100641	28-622	700 x 28C	● foldable	280	95-116
0100642	32-622	700 x 32C	● foldable	350	85-102

Gatorskin Black Edition

PolyX Breaker - 3/180 TPI

Article	ETRTO	Dimension	Color/sidewall	g	PSI
0101728	23-622	700 x 23C	● foldable	220	110-120
0101729	25-622	700 x 25C	● foldable	240	95-120
0101730	28-622	700 x 28C	● foldable	280	95-116
0101731	32-622	700 x 32C	● foldable	350	85-102

Gator Hardshell

Hardshell - 3/180 TPI

Article	ETRTO	Dimension	Color/sidewall	g	PSI
0100311	23-622	700 x 23C	● foldable	260	110-120
0100313	25-622	700 x 25C	● foldable	270	95-120
0100639	28-622	700 x 28C	● foldable	330	95-116
0100640	32-622	700 x 32C	● foldable	375	85-102
0100310	23-622	700 x 23C	● Wire	340	110-120
0100312	25-622	700 x 25C	● Wire	340	95-120
0100314	28-622	700 x 28C	● Wire	400	95-116
0100435	32-622	700 x 32C	● Wire	445	85-102
0100315	32-630	27 x 1¼	● Wire	450	85-102

Gator Hardshell Black Edition

Hardshell - 3/180 TPI

Article	ETRTO	Dimension	Color/sidewall	g	PSI
0101724	23-622	700 x 23C	● foldable	260	110-120
0101725	25-622	700 x 25C	● foldable	270	95-120
0101726	28-622	700 x 28C	● foldable	330	95-116
0101727	32-622	700 x 32C	● foldable	375	85-102

Ultra Sport III

PureGrip Compound - 3/180 TPI

E25

Article	ETRTO	Dimension	Color/sidewall	g	PSI
0150472	25-584	650 x 25B	● foldable	250	95-120
0150475	28-584	650 x 28B	● foldable	275	95-116
0150449	23-622	700 x 23C	● foldable	250	110-120
0150452	23-622	700 x 23C	● foldable	255	110-120
0150453	23-622	700 x 23C	● foldable	255	110-120
0150454	23-622	700 x 23C	● foldable	255	110-120
0150455	23-622	700 x 23C	● foldable	255	110-120
0150456	23-622	700 x 23C	● foldable	255	110-120
0150457	25-622	700 x 25C	● foldable	270	95-120
0150461	25-622	700 x 25C	● foldable	275	95-120
0150462	25-622	700 x 25C	● foldable	275	95-120
0150463	25-622	700 x 25C	● foldable	275	95-120
0150464	25-622	700 x 25C	● foldable	275	95-120
0150465	25-622	700 x 25C	● foldable	275	95-120
0150466	28-622	700 x 28C	● foldable	295	80-116
0150473	25-584	650 x 25B	● Wire	315	95-120
0150476	28-584	650 x 28B	● Wire	345	95-116
0150450	23-622	700 x 23C	● Wire	320	110-120
0150459	25-622	700 x 25C	● Wire	335	95-120
0150468	28-622	700 x 28C	● Wire	365	80-116
0150470	32-622	700 x 32C	● Wire	400	65-102
0150471	32-630	27 x 1¼	● Wire	400	65-102

Gator Hardshell
GO HARDSHELL OR GO HOME

Ideal when it comes to extremely long service life, for the next tour or the commute. Made for for rough surfaces and rugged tarmac. With DuraSkin® sidewall reinforcement (comes in black with our Black Edition).



ARTICLE LIST following page



Grand Sport Extra | Grand Sport Race
PROVEN RACING TIRE CONTOUR FOR RESPONSIVE HANDLING AND SECURE GRIP

Extra: The right choice for all those who eat up the miles, for commuters and gravel kings.

Race: This all-rounder is ready for every challenge, even the biggest ones.



Vectran™ Breaker
PUNCTURE PROTECTION AT IT'S BEST

Vectran™ is spun from liquid crystal-polymer. This way a thermoplastic, multiple-thread yarn is created. As a comparison: This partially crystalline fabric is more cut-resistant than aramide and its tensile strength is five times higher than that of steel. A Vectran™ Breaker is lighter, more flexible and effective against cuts than a comparable nylon breaker. Without effecting rolling resistance.

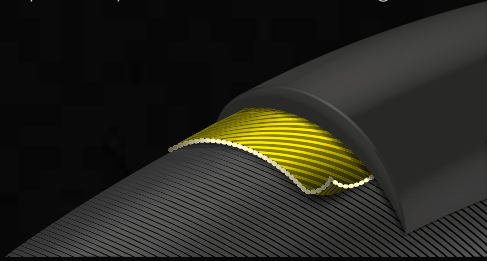

NyTech Breaker
LIGHT AND SLEEK

The Nytech Breaker is based on the technology of our SafetySystem puncture protection. Made of nylon fibre and similar to Kevlar, it reliably protects against punctures and cuts. It also has particularly low rolling resistance and reduced weight, perfect for our performance range of road tires.

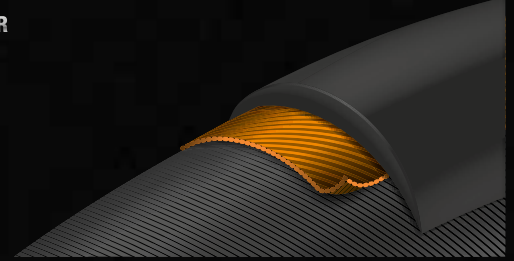

PolyX Breaker™
CUT AND PUNCTURE PROOF

With PolyX Breaker™ car expertise comes to the bicycle tire sector. Polyester has been used successfully for years in car tires and has proved extremely effective. The extremely resistant polyester fibre is woven tightly crosswise. A very high fabric density is achieved which makes the breaker resistant not only to foreign bodies, but especially to punctures. The rolling resistance is not affected by this breaker.

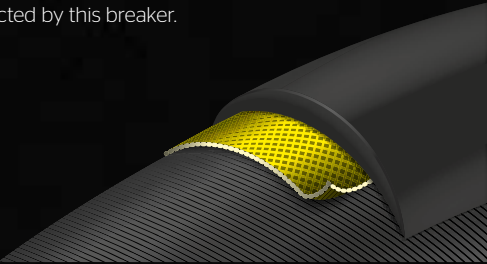

Supersonic
ACCELERATION THE EASY WAY

Low weight and maximum acceleration distinguishes this technology. Time trial specialists and track racers alike profit from its first-rate rolling characteristics.

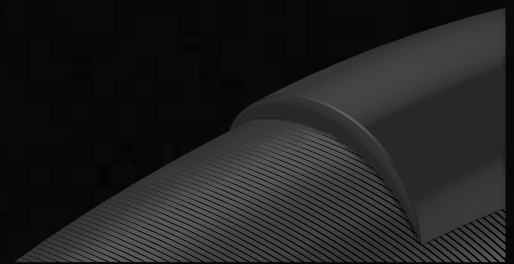

DuraSkin®
FOR HARD CASES

Tires with DuraSkin® sidewall protection can take a beating as they are designed for the most adverse conditions. In rough terrain on a cyclocross or a gravel bike, on commuter bikes where tires scrape along curbs, on touring bikes as they cross continents encountering many different road qualities and on the race circuit where they prove themselves in endurance events such as the Paris-Roubaix. The high-quality polyamide fabric reliably protects the wall of the tire. Tires with DuraSkin® can be identified by the characteristic brown mesh sidewall*.

*DuraSkin® comes in restrained black with our Black Edition



PureGrip Compound
PURE GRIP FOR EVERYONE

PureGrip Compound is derived from an activated Silica compound and is a good example of how we integrate customer feedback continuously into our research and development. This mixture technology fits in perfectly alongside the BlackChili Compound. The name PureGrip does exactly what it says; exceptionally good grip and durability are the distinguishing features of this compound. Engineered with PureGrip in our Performance products in our road and mountain bike ranges.



Hardshell ProTecton
MORE IS WHAT YOU GET

Puncture protection and mileage are the strengths of Hardshell-ProTecton. A wider PolyX Breaker™, the specialist against punctures, under the tread centre and shoulders provides for great reliability. The three-ply - each layer with 60 TPI - carcass covers the entire tire and makes it a real bastion against urban detritus. The outer sidewalls of the tire are reinforced with DuraSkin® fabric providing even more reliability due to the casing being so well protected. Hardshell tires are the puncture-resistant flagship amongst racing tires - produced exclusively in Germany.

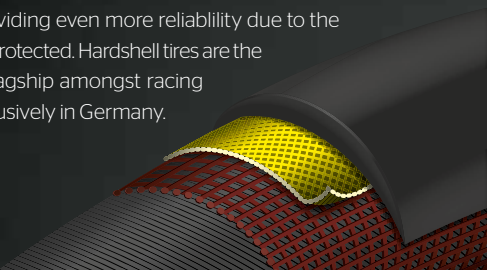

BlackChili Compound
IT'S ALL ABOUT HOW YOU MIX IT

The rolling properties of the rubber compound of a tire are primarily determined by three interacting factors - stiction [grip], rolling resistance and mileage [longevity]. The dilemma: If you improve any of these factors it can have a detrimental effect on at least one of the others. A tire with maximum grip wears quicker and rolls more slowly. If you then make a tire roll faster and more durable, grip, in turn, is reduced.

With our BlackChili Compound, a tread compound which is always based on the latest knowledge of polymers and raw material research, we have supplied the cycling industry with an enduring solution. Depending on the application of a tire, we adjust the compound formulation for the specific discipline - for road or mountain biking, time trialling or downhill racing.

How does that work? For BlackChili, we refine special synthetic rubbers with proven natural rubber to high-performance tread mixtures. To these mixtures we then add soot particles, which in turn are optimised in shape and surface properties. The complex compound technology is so sensitive that tires with BlackChili Compound are produced exclusively in our German Korbach plant.

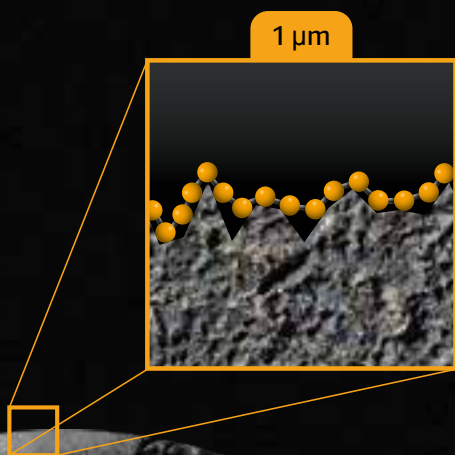

Hometrainer II
THE KM ACCUMULATOR ON THE ROLLERS

Developed for the essential basic training at home. Particularly smooth running. The durable cold-running compound stops heat build up. **! Suitable for training on rollers/home trainers only.**



Super Sport Plus
 Plus Breaker - 3/84 TPI

Article	ETRTO	Dimension	Color/sidewall	g	PSI
0100341	23-622	700 x 23C	● foldable	380	110-120
0100343	25-622	700 x 25C	● foldable	425	95-120
0100344	23-622	700 x 23C	● Wire	440	110-120
0100342	25-622	700 x 25C	● Wire	485	95-120
0100349	28-622	700 x 28C	● Wire	565	80-116
0100347	28-630	27 x 1 1/4	● Wire	590	80-116
0100348	32-630	27 x 1 1/4	● Wire	635	5,0-7,0

Grand Sport Extra
 PureGrip Compound - Double NyTech Breaker - 3/180 TPI

Article	ETRTO	Dimension	Color/sidewall	g	PSI
0150021	23-622	700 X 23C	● foldable	290	110-120
0150024	25-622	700 X 25C	● foldable	315	95-120

PureGrip Compound - Double NyTech Breaker - 3/180 TPI

Article	ETRTO	Dimension	Color/sidewall	g	PSI
0150165	32-622	700 X 32C	● Wire	500	65-102

Grand Sport Race
 PureGrip Compound - NyTech Breaker - 3/180 TPI

Article	ETRTO	Dimension	Color/sidewall	g	PSI
0150001	23-622	700 X 23C	● foldable	245	110-120
0150027	25-622	700 X 25C	● foldable	270	95-120
0150118	28-622	700 X 28C	● foldable	330	80-115
0150141	32-622	700 X 32C	● foldable	390	65-102

PureGrip Compound - NyTech Breaker - 3/180 TPI

Article	ETRTO	Dimension	Color/sidewall	g	PSI
0150025	25-622	700 X 25C	● Wire	340	95-120
0150116	28-622	700 X 28C	● Wire	410	80-115
0150164	32-622	700 X 32C	● Wire	470	65-102

Hometrainer II
 Foldable - 3/180 TPI

Article	ETRTO	Dimension	Color/sidewall	g	PSI
0100648	47-559	26 x 1.75	● foldable	380	45-65
0101275	50-584	27.5 x 2.00	● foldable	385	45-65
0100647	23-622	700 x 23C	● foldable	205	110-120
0100649	32-622	700 x 25C	● foldable	270	85-102

TUBULAR

Podium TT

TIME TRIALS: FOR MAXIMUM ACCELERATION IN THE RACE AGAINST THE CLOCK

High level competition tubular, using an ultra-fast mini diamond tread pattern, perfect for triathlon and time trial specialists.

! Optimized for speed, with limited mileage.



Competition

IT'S TIME TO RACE: THE CLASSIC FOR STRONG ACCELERATION

Robust all-rounder appearing at the sharp end in all the major cycling races around the world. Agile and fast, adapts to the competition in all road conditions.



Set Attack Comp & Force Comp THE AERODYNAMIC RACING TUBULAR SET FOR THE ROAD

Light and fast: developed especially for the demanding requirements of hard, fast racing action. Ideal in combination with the Force Comp. Front and rear have been specifically developed for another and perform ideally when used in combination.



Competition TT EVEN FASTER

Even faster time trial tire due to the delicate carcass. Excellent acceleration thanks to the application of a latex tube. Design updated to a smooth central tread pattern.

! Please consider the special attributes of latex tubes.



Sprinter Gatorskin THE ROBUST SPRINTER, CREATED FOR EXTENDED RIDES AND TRAINING

The roads of Flanders, Roubaix and San Remo are home to this tough tubular. Durable and puncture protected carcass, ready for hundreds of kilometres, even on bad roads.



NEW

ALL LISTINGS
following page



Sprinter

FAST SPRINTER, FOR WINNING THE POINTS

Efficient tires for criteriums or triathlon where the tires winning characteristics will shine through. Neutral slick profile for a direct feel with the road. Full speed ahead!



Giro

FOR NEWCOMERS: THE PERFECT COMPANION FOR TRAINING AND LEISURE RIDES

A reliable all-round tire, high quality for newcomers with high aspirations. High mileage and excellent value for money.



Olympic II

WORLD LEADER ON THE TRACK: THE SPECIALIST FOR AN HOUR RECORD ATTEMPT

Specially developed tire for track racing, their strengths in hard fought races on the wooden boards of the velodrome. Manufactured with no compromise using the highest technological know-how.

The aim: to break records.



Sonderklasse II

WITH ITS SINGLE MINDED DESIGN, THE SIX DAY HERO OF THE WOODEN BOARDS

Extremely light and fast handling tire - made for endurance racing on the wooden boards. A special slick profile for the highest speeds puts this tire into a class of its own in our track racing range.





Tempo II THE VELODROME ALL-ROUNDER FOR ALL TRACK DISCIPLINES

Particularly light and fast racing tire designed for the concrete and wooden surfaces of velodromes. No compromise design: made with a particularly fine carcass and a slightly roughened slick tread.



Grand Prix 4000 S II Tubular SEEMLESS AND GRIPPY CONSTRUCTION, FAST AND PERSISTANT IN ALLROUND PERFORMANCE

The ideal all-rounder for all conceivable conditions especially for the long tour. Provides ideal fitting on the rim, due to its specially developed construction.



Set Attack Comp & Force Comp

BlackChili Compound - Vectran Breaker - 3/180 TPI					
Article	ETRTO	Dimension	Color/sidewall	g	PSI
0100748		28 x 22/24	●	500	115-170

Attack Comp

BlackChili Compound - Vectran Breaker - 3/180 TPI					
Article	ETRTO	Dimension	Color/sidewall	g	PSI
0196231		28 x 22	●	240	115-170

Force Comp

BlackChili Compound - Vectran Breaker - 3/180 TPI					
Article	ETRTO	Dimension	Color/sidewall	g	PSI
0196232		28 x 24	●	260	115-170

Podium TT

BlackChili Compound - Vectran Breaker - 3/180 TPI					
Article	ETRTO	Dimension	Color/sidewall	g	PSI
0196181		28 x 19	●	195	160-220
0196180		28 x 22	●	225	160-170
0196243		28 x 25	●	275	115-170

Competition

BlackChili Compound - Vectran Breaker - 3/180 TPI					
Article	ETRTO	Dimension	Color/sidewall	g	PSI
0196142		26 x 19	●	215	145-170
0196141		26 x 22	●	250	115-170
0196140		28 x 19	●	230	145-170
0196138		28 x 22	●	260	115-170
0196189		28 x 25	●	280	115-170

Competition TT

BlackChili Compound - Vectran Breaker - 3/600 TPI					
Article	ETRTO	Dimension	Color/sidewall	g	PSI
Q3 0196270		28 x 25	●	250	115-170

NEW

Sprinter Gatorskin

SafetySystem Breaker - 3/180 TPI					
Article	ETRTO	Dimension	Color/sidewall	g	PSI
0196136		28 x 22	●	280	115-170
0196187		28 x 25	●	295	115-170

Sprinter

BlackChili Compound - SafetySystem Breaker - 3/180 TPI					
Article	ETRTO	Dimension	Color/sidewall	g	PSI
0196150		26 x 22	●	260	145-170
0196135		28 x 22	●	275	115-170
0196244		28 x 25	●	295	115-170

Giro

Performance - 2/160 TPI					
Article	ETRTO	Dimension	Color/sidewall	g	PSI
0196017		28 x 22	●	300	115-145

Tempo II

BlackChili Compound - 3/180 TPI					
Article	ETRTO	Dimension	Color/sidewall	g	PSI
0196185		28 x 19	●	180	160-220
0196184		28 x 22	●	200	160-170

Olympic II

BlackChili Compound - 3/180 TPI					
Article	ETRTO	Dimension	Color/sidewall	g	PSI
0196186		28 x 19	●	185	170-220

Sonderklasse II

BlackChili Compound - 3/180 TPI					
Article	ETRTO	Dimension	Color/sidewall	g	PSI
0196188		28 x 23	●	220	160-170

Grand Prix 4000 S II Tubular

BlackChili Compound - Vectran Breaker - 4/240 TPI					
Article	ETRTO	Dimension	Color/sidewall	g	PSI
0196241		28 x 22	●	270	115-170

URBAN TOUR

Grand Prix Urban THE STATEMENT TIRE FOR THE CITY

Combines a modern tread pattern design with the latest technology. Built with a tuned race construction while damping for comfort - a matching mix for the urban ride. Its black reflective stripe blends perfectly with the sidewall.



Developed together with
schindelhauer

Ink

Coffee

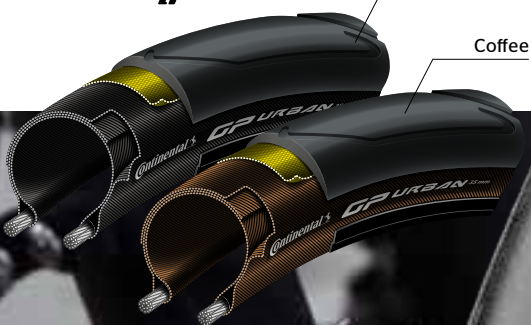

CONTACT Urban CYCLING ON THE CITY PULSE



Premium mobility for design enthusiasts. Urban tread pattern packed with the latest technology. The perfect symbiosis between light-rolling and puncture protection reflected in this specialized tire designed for the city jungle.

Faster? Not a problem with approval for e-bikes up to 50km/h.



Urban TaraxaGum GIVE SOMETHING BACK TO YOUR CITY!

The tire made from dandelions, for the sustainable lifestyle. Grown and made in Germany. Comfortable race construction - ideal for the urban ride.



Grand Prix Urban

BlackChili Compound - PolyX Breaker - 3/180 TPI

Article	ETRTO	Dimension	Color/sidewall	g	PSI
0101575	35-622	28 x 1 3/8 x 1 3/8	● foldable	345	65-85
0101673	35-622	28 x 1 3/8 x 1 3/8	● foldable	335	65-85

Urban TaraxaGum

TaraxaGum - Vectran Breaker - 3/180 TPI

Article	ETRTO	Dimension	Color/sidewall	g	PSI
0101675	35-622	28 x 1 3/8 x 1 3/8	● foldable	340	65-85

CONTACT Urban

PureGrip Compound - SafetyPro - 3/180 TPI



Article	ETRTO	Dimension	Color/sidewall	g	PSI	kg+
Q2 0150567	35-349	16 x 1.35	● Wire refl.	265	65-116	65
0150365	32-406	20 x 1.25	● Wire refl.	545	65-102	71
0150352	42-406	20 x 1.60	● Wire refl.	545	58-85	75
0150354	50-406	20 x 2.00	● Wire refl.	430	50-73	80
0150366	47-559	26 x 1.75	● Wire refl.	545	45-73	112
0150355	50-559	26 x 2.00	● Wire refl.	590	50-73	121
0150367	55-559	26 x 2.20	● Wire refl.	545	36-65	132
0150353	42-584	27.5 x 1.60	● Wire refl.	515	58-94	106
0150357	50-584	27.5 x 2.00	● Wire refl.	615	36-73	121
0150368	55-584	27.5 x 2.20	● Wire refl.	545	36-65	132
0150369	28-622	28 x 1 1/4 x 1 1/4	● Wire refl.	400	80-109	85
0150370	32-622	28 x 1 1/4 x 1 1/4	● Wire refl.	445	65-94	90
0150371	35-622	28 x 1 1/4 x 1 1/4	● Wire refl.	465	65-94	95
0150350	37-622	28 x 1 1/4 x 1 1/4	● Wire refl.	485	58-94	100
0150351	40-622	28 x 1.50	● Wire refl.	545	58-94	100
0150349	42-622	28 x 1.60	● Wire refl.	545	50-85	106
0150372	47-622	28 x 1.75	● Wire refl.	625	45-73	115
0150358	50-622	28 x 2.00	● Wire refl.	655	50-73	121
0150373	55-622	28 x 2.20	● Wire refl.	545	36-65	132





Top CONTACT II THE PROVEN FAST TREKKING ALL-ROUNDER

Premium-allrounder: Riding fast and safe on the road, gravel or forest paths. Outstanding rolling characteristics fostered by a broad central tread pattern and a high-end fabric breaker.

ECE-R75-certified: Recommended for e-bikes up to 50km/h.



Top CONTACT Winter II Premium PREMIUM TIRE FOR COLD SEASONS

Full control on slippery, snowy roads and dank surfaces thanks to its grippy lamellar tread pattern. Riders of this tire benefit from our know-how as leading manufacturer of winter tires for cars and trucks.

ECE-R75-certified: Recommended for e-bikes up to 50km/h.



CONTACT Plus City OUT AND ABOUT IN TOWN

Exactly the right tire to explore the city securely and relaxed thanks to a tread pattern made for tarmac, efficient rolling characteristics, and a maximum of puncture protection. With its ECE-R75-certification, cyclists can ride economically and save energy even on e-bikes up to 50km/h.



CONTACT Plus Travel FOR RACKING UP THE KILOMETERS ON TREKKING TOURS

The best companion for your next adventure. Its all-purpose tread pattern ensures a secure ride on the countryside, forest trails or meadow paths - even when the terrain gets rough.



Top CONTACT II						
Vectran Breaker - 3/180 TPI E50 6						
Article	ETRTO	Dimension	Color/sidewall	g	PSI	kg+
0101735	50-559	26 x 2.00	● foldable refl.	735	45-65	109
0101279	50-584	27.5 x 2.00	● foldable refl.	760	45-65	121
0100615	28-622	28 x 1 1/4 x 1 1/4	● foldable refl.	470	80-102	85
0100573	32-622	28 x 1 1/4 x 1 1/4	● foldable refl.	525	70-85	85
0100441	37-622	28 x 1 1/4 x 1 1/4	● foldable refl.	610	58-85	85
0100358	42-622	28 x 1.60	● foldable refl.	760	50-85	85
0100439	47-622	28 x 1.75	● foldable refl.	800	45-65	95

Top CONTACT Winter II Premium						
Vectran Breaker - 3/180 TPI E50 6						
Article	ETRTO	Dimension	Color/sidewall	g	PSI	kg+
0100712	50-559	26 x 1.90	● foldable refl.	610	45-58	121
0101734	55-559	26 x 2.20	● foldable refl.	745	45-58	128
0101281	50-584	27.5 x 2.00	● foldable refl.	640	45-65	121
0100713	37-622	28 x 1 1/4 x 1 1/4	● foldable refl.	470	58-85	95
0100714	42-622	28 x 1.60	● foldable refl.	685	50-85	100

CONTACT Plus						
SafetyPlus Breaker - 3/180 TPI E50 7						
Article	ETRTO	Dimension	Color/sidewall	g	PSI	kg+
Q3 0101749	47-406	20 x 1.75	● Wire refl.	865	50-58	80
Q3 0101750	50-406	20 x 2.00	● Wire refl.	880	50-73	85
Q3 0101751	55-406	20 x 2.20	● Wire refl.	970	45-73	90
Q3 0101755	62-406	20 x 2.50	● Wire refl.	1150	45-58	115
0101001	47-507	24 x 1.75	● Wire refl.	940	45-58	90
0101002	47-559	26 x 1.75	● Wire refl.	1040	45-58	109
0101221	42-584	27.5 x 1 1/2	● Wire refl.	990	50-65	100
0101003	28-622	28 x 1 1/4 x 1 1/4	● Wire refl.	645	80-102	85
0101004	32-622	28 x 1 1/4 x 1 1/4	● Wire refl.	750	70-85	90
0101005	37-622	28 x 1 1/4 x 1 1/4	● Wire refl.	980	58-85	100

CONTACT Plus

ALL YOU WOULD EXPECT FROM A COMFORTABLE TIRE

An allrounder on any type of roads and paths that enhances every bike. Thanks to the plus in puncture protection, nobody will be left behind with a flat tire.

ECE-R75-certified, designated for usage on e-bikes up to 50km/h.



NEW SIZES

Up to **30% higher puncture protection*** against glass and sharp flints!

* Benchmark test: Piercing (blade) test measuring force required, Zeidler Instituto, 2016 - further details of the test: www.continental-tires.com/bicycle/technology

CONTACT Plus						
SafetyPlus Breaker - 3/180 TPI E50 7						
Article	ETRTO	Dimension	Color/sidewall	g	PSI	kg+
Q3 0101816	40-622	28 x 1.50	● Wire refl.	980	58-94	100
0101006	42-622	28 x 1.60	● Wire refl.	1050	50-73	100
0101007	47-622	28 x 1.75	● Wire refl.	1150	45-58	95
0101008	42-635	28 x 1 1/2	● Wire refl.	1070	50-65	100

CONTACT Plus City						
SafetyPlus Breaker - 3/180 TPI E50 7						
Article	ETRTO	Dimension	Color/sidewall	g	PSI	kg+
0101331	47-559	26 x 1.75	● Wire refl.	1000	45-58	109
0101334	55-559	26 x 2.20	● Wire refl.	1230	45-58	121
0101335	55-584	27.5 x 2.20	● Wire refl.	1270	45-58	128
0101336	37-622	28 x 1 1/4 x 1 1/4	● Wire refl.	900	58-85	95
0101340	42-622	28 x 1.60	● Wire refl.	990	50-73	100
0101343	47-622	28 x 1.75	● Wire refl.	1130	45-58	95

CONTACT Plus Travel						
SafetyPlus Breaker - 3/180 TPI E25 7						
Article	ETRTO	Dimension	Color/sidewall	g	PSI	
0101346	47-559	26 x 1.75	● Wire refl.	925	45-58	
0101347	50-559	26 x 2.00	● Wire refl.	1100	45-58	
0101348	37-622	28 x 1 3/8 x 1 3/8	● Wire refl.	820	58-87	
0101349	42-622	28 x 1.60	● Wire refl.	930	50-73	
0101350	47-622	28 x 1.75	● Wire refl.	1020	45-58	

CONTACT						
SafetySystem Breaker - 3/180 TPI E25 4						
Article	ETRTO	Dimension	Color/sidewall	g	PSI	
0101311	37-406	20 x 1.40	● Wire refl.	420	56-73	
0101310	37-406	20 x 1.40	● Wire	420	56-73	
0101313	47-406	20 x 1.75	● Wire refl.	505	45-58	
0101312	47-406	20 x 1.75	● Wire	505	45-58	
0101315	47-559	26 x 1.75	● Wire refl.	670	45-58	
0101314	47-559	26 x 1.75	● Wire	670	45-58	
0101317	28-622	28 x 1 1/4 x 1 1/4	● Wire refl.	480	80-102	
0101316	28-622	28 x 1 1/4 x 1 1/4	● Wire	480	80-102	
0101319	32-622	28 x 1 1/4 x 1 1/4	● Wire refl.	495	70-85	
0101318	32-622	28 x 1 1/4 x 1 1/4	● Wire	495	70-85	
0101320	37-622	28 x 1 1/4 x 1 1/4	● Wire refl.	610	56-85	
0101321	37-622	28 x 1 1/4 x 1 1/4	● Wire	610	56-85	
0101324	42-622	28 x 1.60	● Wire refl.	645	50-85	
0101325	42-622	28 x 1.60	● Wire	645	50-85	
0101328	47-622	28 x 1.75	● Wire refl.	770	45-58	
0101327	47-622	28 x 1.75	● Wire	770	45-58	

CONTACT Speed						
SafetySystem Breaker - 3/180 TPI E25 4						
Article	ETRTO	Dimension	Color/sidewall	g	PSI	
0101388	28-406	20 x 1.10	● Wire refl.	265	70-87	
0101387	28-406	20 x 1.10	● Wire	265	70-87	
0101391	32-559	26 x 1.30	● Wire refl.	430	70-87	
0101389	32-559	26 x 1.30	● Wire	430	70-87	
0101392	42-559	26 x 1.60	● Wire refl.	540	65-87	
0101393	42-559	26 x 1.60	● Wire	540	65-87	
0101396	50-559	26 x 2.00	● Wire refl.	665	45-58	
0101395	50-559	26 x 2.00	● Wire	665	45-58	
0101398	32-584	27.5 x 1.25	● Wire refl.	470	70-87	
0101397	32-584	27.5 x 1.25	● Wire	470	70-87	
0101399	50-584	27.5 x 2.00	● Wire refl.	700	50-65	
0101401	50-584	27.5 x 2.00	● Wire	700	50-65	
0101403	28-622	28 x 1 1/4 x 1 1/4	● Wire refl.	425	80-102	
0101402	28-622	28 x 1 1/4 x 1 1/4	● Wire	425	80-102	
0101408	32-622	28 x 1 1/4 x 1 1/4	● Wire refl.	485	70-87	
0101406	32-622	28 x 1 1/4 x 1 1/4	● Wire	485	70-87	
0101414	37-622	28 x 1 1/4 x 1 1/4	● Wire refl.	495	70-87	
0101412	37-622	28 x 1 1/4 x 1 1/4	● Wire	495	70-87	

ARTICLE LIST
[previous page](#)

ARTICLE LIST
[previous page](#)



CONTACT WHEN THINGS GET TOUGH

Versatile allrounder which connects reliably to every surface. Equipped with the most popular tread pattern from the urban/tour range, especially designed for a high degree of safety thanks to its lamellar structure.

Safety  System 

CONTACT Speed UNITES SPEED AND COMFORT IN ONE TIRE

The perfect choice for the city speedsters, single-speed bikes and fitness bikes. With its double layer of fabric breaker, the light-weight design and its roughened slick tread it shines especially on tarmac.

Safety  System 

CONTACT Spike 120 and 240 OUR RECOMMENDATION FOR SNOW AND ICY ROADS

Safety during cold and dark seasons: The spikes guarantee traction, the reflective stripes ensure visibility. Maintain full control of your bicycle even in turns and hard stops.

Choose between 120 or 240 spikes.

Safety  System 



**NEW
SIZES**

CONTACT Cruiser CHIC CRUISER

Voluminous lifestyle tire featuring high comfort for a high performance especially on tarmac. A fabric breaker provides light-rolling puncture protection. Available in different colors and dimensions.

Safety System 



CONTACT Travel YOUR TICKET AROUND THE WORLD: THE GLOBETROTTER

Your companion for endurance rides on touring and all terrain bikes. Additional sidewall protection makes the carcass extremely resistant and durable. Also available as foldable version to take it with you on tour.

Safety System  

CONTACT Speed

SafetySystem Breaker - 3/180 TPI						E25	4
Article	ETRTO	Dimension	Color/sidewall	g	PSI		
0101418	42-622	28 x 1.60	● Wire refl.	590	50-87		
0101416	42-622	28 x 1.60	● Wire	590	50-87		
0101637	32-584	27.5 x 1.25	● foldable	390	70-87		
0101632	28-622	28 x 1 1/8 x 1 1/4	● foldable	345	80-102		
0101633	32-622	28 x 1 1/4 x 1 1/4	● foldable	420	70-87		
0101634	35-622	28 x 1 1/8 x 1 1/4	● foldable	405	70-87		
0101635	37-622	28 x 1 1/8 x 1 1/4	● foldable	415	70-87		
0101636	42-622	28 x 1.60	● foldable	510	50-87		

CONTACT Cruiser

SafetySystem Breaker - 3/180 TPI						E25	4
Article	ETRTO	Dimension	Color/sidewall	g	PSI		
Q3 0101754	50-406	20 x 2.00	● Wire refl.	615	50-73		
0101507	50-559	26 x 2.00	● Wire refl.	850	45-65		
0101509	50-559	26 x 2.00	● Wire refl.	850	45-65		
0101508	50-559	26 x 2.00	● Wire refl.	850	45-65		
0101510	50-559	26 x 2.00	● Wire refl.	850	45-65		
0101511	55-559	26 x 2.20	● Wire refl.	905	45-65		
0101513	55-559	26 x 2.20	● Wire refl.	905	45-65		
0101512	55-559	26 x 2.20	● Wire refl.	905	45-65		
0101514	55-559	26 x 2.20	● Wire refl.	905	45-65		
Q3 0101753	60-584	27.5 x 2.40	● Wire refl.	1025	45-58		
0101515	50-622	28 x 2.00	● Wire refl.	960	45-65		
0101517	50-622	28 x 2.00	● Wire refl.	960	45-65		
0101516	50-622	28 x 2.00	● Wire refl.	960	45-65		
0101518	50-622	28 x 2.00	● Wire refl.	960	45-65		
0101519	55-622	28 x 2.20	● Wire refl.	1025	45-65		
0101521	55-622	28 x 2.20	● Wire refl.	1025	45-65		
0101520	55-622	28 x 2.20	● Wire refl.	1025	45-65		
0101522	55-622	28 x 2.20	● Wire refl.	1025	45-65		

CONTACT Travel

SafetySystem Breaker - 3/180 TPI						E25	4
Article	ETRTO	Dimension	Color/sidewall	g	PSI		
0101496	47-559	26 x 1.75	● Wire refl.	670	50-80		
0101494	47-559	26 x 1.75	● Wire	670	50-80		
0101498	50-559	26 x 2.00	● Wire	760	45-58		
0101499	50-559	26 x 2.00	● Wire refl.	760	45-58		
0101501	37-622	28 x 1 1/8 x 1 1/4	● Wire refl.	575	56-85		
0101500	37-622	28 x 1 1/8 x 1 1/4	● Wire	575	56-85		
0101504	42-622	28 x 1.60	● Wire refl.	620	50-85		
0101503	42-622	28 x 1.60	● Wire	620	50-85		
0101505	50-622	28 x 2.00	● Wire	845	45-58		
0101506	50-622	28 x 2.00	● Wire refl.	845	45-58		
0101497	47-559	26 x 1.75	● foldable	590	50-80		
0101502	37-622	28 x 1 1/8 x 1 1/4	● foldable	510	56-85		

CONTACT Spike 120

SafetySystem Breaker - 3/180 TPI						E25	4
Article	ETRTO	Dimension	Color/sidewall	g	PSI		
0150498	32-622	28 x 1 1/4 x 1 1/4	● Wire refl.	690	65-94		
0150269	37-622	28 x 1 1/8 x 1 1/4	● Wire refl.	790	56-73		
0150268	42-622	28 x 1.60	● Wire refl.	930	50-87		

CONTACT Spike 240

SafetySystem Breaker - 3/180 TPI						E25	4
Article	ETRTO	Dimension	Color/sidewall	g	PSI		
0150091	37-622	28 x 1 1/8 x 1 1/4	● Wire refl.	850	56-73		
0150191	42-622	28 x 1.60	● Wire refl.	995	50-87		

**NEW
SIZES**



**RIDE Tour
A LOYAL COMPANION ON YOUR REGULAR RIDES**

Tarmac, gravel, urban environment - the right tire for your daily ride thanks to robust puncture protection and an additional rubber layer for high mileage. Available in a large range of colors and sizes.



**RIDE Cruiser
RIDE RETRO!**

Balloon tire in the retro look of the legendary Conti KKS10, developed for stylish cruisers with high comfort. Available in various trendy colors and sizes.



**NEW
SIZES**

**NEW
COLORS**



**RIDE City
A ROBUST TIRE WITH A MODERN LOOK**

High reliability and always on time in urban traffic: Solid tire for city bikes. Proven successful on tarmac as well as on gravel thanks to good traction provided by its broad contact area in the tread pattern.



**Speed RIDE
THE QUICK SEMI-SLICK FOR RIDING IN TOWN**

The diamond studded tread design balances smooth rolling on asphalt and traction in turns in city parks. Also available in the practical and lightweight folding version.





NEW COLOR

ARTICLE LIST following page

RIDE Tour						
ExtraPuncture Belt - 3/180 TPI					E25	U5
Article	ETRTO	Dimension	Color/sidewall	g	PSI	
0101137	62-203	12½ x 2¼	● Wire	405	45-58	
0101139	47-305	16 x 1.75	● Wire refl.	490	45-58	
0101138	47-305	16 x 1.75	● Wire	490	45-58	
0101142	47-406	20 x 1.75	● Wire refl.	600	45-58	
0101140	47-406	20 x 1.75	● Wire	600	45-58	
0101184	47-406	20 x 1.75	◐ Wire	630	45-58	
0101144	47-507	24 x 1.75	● Wire refl.	720	45-58	
0101143	47-507	24 x 1.75	● Wire	720	45-58	
0101186	47-507	24 x 1.75	◐ Wire	810	45-58	
0101149	47-559	26 x 1.75	● Wire refl.	780	45-58	
0101148	47-559	26 x 1.75	● Wire	780	45-58	
0101181	47-559	26 x 1.75	● Wire	870	45-58	
0101189	47-559	26 x 1.75	◐ Wire	870	45-58	
Q2 0101175	47-559	26 x 1.75	● Wire refl.	870	45-58	
0101187	37-584	26/27.5 x 1½	◐ Wire	690	56-70	
0101147	42-584	26/27.5 x 1½	● Wire refl.	720	50-65	
0101146	42-584	26/27.5 x 1½	● Wire	720	50-65	
0101168	54-584	26/27.5 x 1½ x 2	● Wire refl.	950	45-58	
0101150	54-584	26/27.5 x 1½ x 2	● Wire	950	45-58	
0101433	37-609	27 x 1¾ x 1½	● Wire	685	56-70	
0101152	28-622	28 x 1¾ x 1¾	● Wire refl.	540	70-102	
0101151	28-622	28 x 1¾ x 1¾	● Wire	540	70-102	
0101154	32-622	28 x 1¼ x 1¾	● Wire refl.	640	70-80	
0101153	32-622	28 x 1¼ x 1¾	● Wire	640	70-80	
0101188	32-622	28 x 1¼ x 1¾	◐ Wire	600	70-80	
0101156	37-622	28 x 1¾ x 1¾	● Wire refl.	690	56-70	
0101155	37-622	28 x 1¾ x 1¾	● Wire	690	56-70	
0101180	37-622	28 x 1¾ x 1¾	● Wire	725	56-70	
0101193	37-622	28 x 1¾ x 1¾	◐ Wire	725	56-70	
0101182	37-622	28 x 1¾ x 1¾	● Wire refl.	725	56-70	
0101177	37-622	28 x 1¾ x 1¾	● Wire	725	56-70	
0101167	42-622	28 x 1.60	● Wire refl.	790	50-65	
0101157	42-622	28 x 1.60	● Wire	790	50-65	
0101176	42-622	28 x 1.60	● Wire refl.	790	50-65	
0101160	47-622	28 x 1.75	● Wire refl.	900	45-58	
0101159	47-622	28 x 1.75	● Wire	900	45-58	
0101179	47-622	28 x 1.75	● Wire	960	45-58	
0101194	47-622	28 x 1.75	◐ Wire	960	45-58	
Q2 0101178	47-622	28 x 1.75	● Wire refl.	960	45-58	
0101656	47-622	28 x 1.75	● Wire refl.	960	45-58	
0101185	47-622	28 x 1.75	● Wire	960	45-58	
0101162	32-630	27 x 1¼	● Wire refl.	660	70-80	
0101161	32-630	27 x 1¼	● Wire	660	70-80	
0101183	32-630	27 x 1¼	◐ Wire	610	70-80	
0101164	37-635	28 x 1¾	● Wire refl.	710	56-70	
0101163	37-635	28 x 1¾	● Wire	710	56-70	
Q2 0101192	37-635	28 x 1¾	● Wire refl.	665	56-70	
0101166	42-635	28 x 1½	● Wire refl.	820	50-65	
0101165	42-635	28 x 1½	● Wire	820	50-65	

RIDE Classic THE CLASSIC

With its classic tread pattern design this is the right tire for your Dutch bike or style bike. It provides a pleasant riding experience especially on tarmac. Available in various trendy colors and sizes.



ARTICLE LIST following page



AT RIDE ALL TERRAIN: THE TREKKING ALL-ROUNDER

The lean trekking tire with no fear of loose or slippery surfaces due to its resistant carcass and mountainbike-inspired tread pattern.



RIDE City						
ExtraPuncture Belt - 3/180 TPI					E25	U5
Article	ETRTO	Dimension	Color/sidewall	g	PSI	
0101552	47-559	26 x 1.75	● Wire refl.	940	45-58	
Q2 0101652	47-559	26 x 1.75	● Wire refl.	960	45-58	
Q2 0101651	47-559	26 x 1.75	● Wire refl.	930	45-58	
0101553	32-622	28 x 1¼ x 1¾	● Wire refl.	700	70-80	
0101554	37-622	28 x 1¾ x 1¾	● Wire refl.	850	51-65	
Q2 0101603	37-622	28 x 1¾ x 1¾	● Wire refl.	850	51-65	
Q2 0101604	37-622	28 x 1¾ x 1¾	● Wire refl.	850	51-65	
Q2 0101650	37-622	28 x 1¾ x 1¾	● Wire refl.	820	51-65	
0101649	37-622	28 x 1¾ x 1¾	● Wire refl.	820	51-65	
0101555	42-622	28 x 1.60	● Wire refl.	950	50-65	
Q2 0101605	42-622	28 x 1.60	● Wire refl.	950	50-65	
Q2 0101657	42-622	28 x 1.60	◐ Wire refl.	950	50-65	

SafetyPlus Breaker

THE ANTI-PUNCTURE SPECIALIST

Specially designed for e-bikes up to 50 km/h, we have combined our SafetySystem Breaker with a highly flexible natural rubber. The result is an extremely cut and puncture resistant breaker ply which has a low rolling resistance thanks to its high elasticity. This helps saving battery life and the environment. High acceleration torques and fast speeds in turns are easily absorbed by the breaker. The specialist for fast e-bikes and rental bikes.



Vectran™ Breaker

PUNCTURE PROTECTION AT IT'S BEST

Vectran™ is spun from liquid crystal-polymer. This way a thermoplastic, multiple-thread yarn is created. As a comparison: This partially crystalline fabric is more cut-resistant than aramide and its tensile strength is five times higher than that of steel. A Vectran™ Breaker is lighter, more flexible and effective against cuts than a comparable nylon breaker. Without effecting rolling resistance.



SafetyPro Breaker

LIGHTWEIGHT PUNCTURE PROTECTION

The new SafetyPro Breaker designed from nylon textile. Cross-woven textile fiber netting that is simultaneously robust and flexible. Maximum puncture protection with minimal added weight. The risk of punctures resulting from glass or sharp stones is substantially reduced.



EXTRA PunctureBelt

CAREFREE ON A DAILY BASIS

Anyone looking for a reliable everyday companion will go for a tire with EXTRA PunctureBelt. This rugged rubber breaker, combined with the rubber-reinforced sidewalls of the tire, ensures a high level of puncture protection and sidewall abrasion. Where durability is the main focus, there is also a solid tire version.

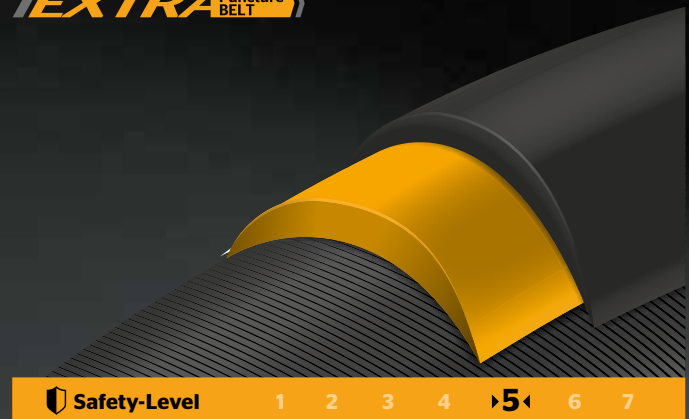

Up to **30% higher puncture protection*** against glass and sharp flints!



* Benchmark test: Piercing (blade) test measuring force required, Zedler Institute, 2016 - further details of the test: www.continental-tires.com/bicycle/technology



Puncture ProTecton

THE NAME SPEAKS FOR ITSELF

An impeccable rubber Breaker, created for the daily ride on your Urban/Tour bike. The breaker ensures a high level of puncture protection and sidewall abrasion.

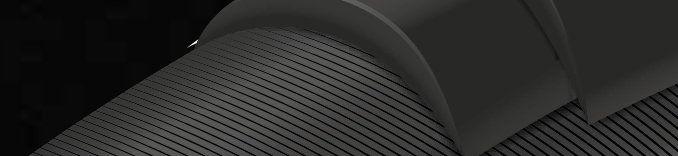

Safety-Level 1 2 3 4 **5** 6 7

SafetySystem Breaker

PUNCTURE PROTECTION AS A SYSTEM

The SafetySystem Breaker consists of a Kevlar-reinforced, high-strength nylon fabric. Puncture and cut resistant, whilst also being light and flexible, allowing the tire to adapt more effectively to the terrain. The breaker protects the carcass against foreign objects and contributes to a longer lifespan of the tire without significantly increasing weight or rolling resistance. Additionally, tires with SafetySystem have particularly comfortable handling characteristics.

Safety System

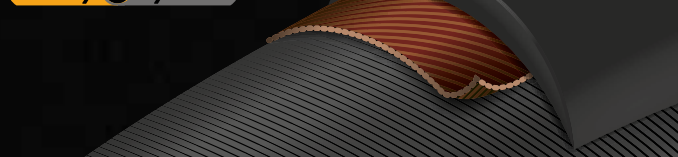

Safety-Level 1 2 3 **4** 5 6 7

DuraSkin®

FOR HARD CASES

Tires with DuraSkin® sidewall protection can take a beating as they are designed for the most adverse conditions. In rough terrain on a cyclocross or a gravel bike, on commuter bikes where tires scrape along curbs, on touring bikes as they cross continents encountering many different road qualities and on the race circuit where they prove themselves in endurance events such as the Paris-Roubaix. The high-quality polyamide fabric reliably protects the wall of the tire. Tires with DuraSkin® can be identified by the characteristic brown mesh sidewall*.

*DuraSkin® comes in restrained black with our Black Edition

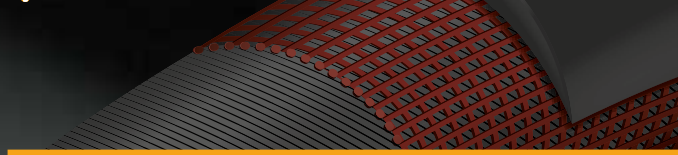

Safety-Level 1 2 3 **4** 5 6 7

RIDE City

ExtraPuncture Belt - 3/180 TPI

E25 **U5**

Article	ETRTO	Dimension	Color/sidewall	g	PSI
Q2 0101648	42-622	28 x 1.60	● Wire refl.	950	50-65
0101647	42-622	28 x 1.60	● Wire refl.	910	50-65
0101556	47-622	28 x 1.75	● Wire refl.	1100	45-58
Q2 0101607	47-622	28 x 1.75	● Wire refl.	1100	45-58
Q2 0101679	47-622	28 x 1.75	● Wire refl.	1100	45-58
Q2 0101658	47-622	28 x 1.75	● Wire refl.	1160	45-58
Q2 0101608	47-622	28 x 1.75	● Wire refl.	1100	45-58
Q2 0101646	47-622	28 x 1.75	● Wire refl.	1050	45-58
Q2 0101645	47-622	28 x 1.75	● Wire refl.	1050	45-58

RIDE Cruiser

ExtraPuncture Belt - 3/180 TPI

E25 **U5**

Article	ETRTO	Dimension	Color/sidewall	g	PSI
0101523	50-559	26 x 2.00	● Wire refl.	1000	45-58
0101524	50-559	26 x 2.00	● Wire refl.	1000	45-58
0101525	50-559	26 x 2.00	● Wire refl.	1000	45-58
0101526	50-559	26 x 2.00	● Wire refl.	1000	45-58
0101527	55-559	26 x 2.20	● Wire refl.	1020	45-58
0101528	55-559	26 x 2.20	● Wire refl.	1020	45-58
0101529	55-559	26 x 2.20	● Wire refl.	1020	45-58
0101530	55-559	26 x 2.20	● Wire refl.	1020	45-58
0101531	50-622	28 x 2.00	● Wire refl.	1130	45-58
0101532	50-622	28 x 2.00	● Wire refl.	1130	45-58
0101533	50-622	28 x 2.00	● Wire refl.	1130	45-58
0101534	50-622	28 x 2.00	● Wire refl.	1130	45-58
0101535	55-622	28 x 2.20	● Wire refl.	1120	45-58
0101536	55-622	28 x 2.20	● Wire refl.	1120	45-58
0101537	55-622	28 x 2.20	● Wire refl.	1120	45-58
0101538	55-622	28 x 2.20	● Wire refl.	1120	45-58

RIDE Classic

ExtraPuncture Belt - 3/180 TPI

E25 **U5**

Article	ETRTO	Dimension	Color/sidewall	g	PSI
0101539	37-622	28 x 1½ x 1½	● Wire refl.	820	70-85
0101541	37-622	28 x 1½ x 1½	● Wire refl.	820	70-85
0101540	37-622	28 x 1½ x 1½	● Wire refl.	820	70-85
0101542	37-622	28 x 1½ x 1½	● Wire refl.	820	70-85
0101543	42-622	28 x 1.60	● Wire refl.	900	50-65
0101545	42-622	28 x 1.60	● Wire refl.	900	50-65
0101544	42-622	28 x 1.60	● Wire refl.	900	50-65
0101546	42-622	28 x 1.60	● Wire refl.	900	50-65
0101547	40-635	28 x 1½ [1½]	● Wire refl.	820	50-65
Q2 0101564	40-635	28 x 1½ [1½]	● Wire refl.	820	50-65
0101549	40-635	28 x 1½ [1½]	● Wire refl.	820	50-65
0101548	40-635	28 x 1½ [1½]	● Wire refl.	820	50-65
0101550	40-635	28 x 1½ [1½]	● Wire refl.	820	50-65

Speed RIDE

Puncture ProTecton - 3/180 TPI

E25 **U5**

Article	ETRTO	Dimension	Color/sidewall	g	PSI
0100717	42-622	28 x 1.60	● foldable	440	50-85
0100716	42-622	28 x 1.60	● Wire refl.	505	50-85

AT RIDE

Puncture ProTecton - 3/180 TPI

E25 **U5**

Article	ETRTO	Dimension	Color/sidewall	g	PSI
0101429	42-622	28 x 1.60	● foldable	435	50-85
0101428	42-622	28 x 1.60	● Wire refl.	520	50-85

TUBES

With the ContiTube program, you can find the inner tube most suited to your needs. Depending on your tire dimensions and purpose, different sizes, types, valve types and widths are available.

All

The all-rounder for day to day demands. Available in all usual dimensions.

Light and Supersonic

Perceptible optimization of weight and rolling resistance due to thinner material. ! Light tubes generally require more frequent reinflating.

Hermetic Plus

The all-round carefree product. Designed for the most comprehensive puncture protection and air retention due to enhanced butyl content and increased wall thickness.

Freeride and Downhill

Extra strong and increased volume. Effectively protects against punctures thanks to thicker material.



Auto Schrader



Blitz Dunlop



Sclaverand Presta



Sclaverand Presta



Sclaverand Presta

A34

A34 45°

A40

D26

D40

S42

S60

S80

Workshop (50pcs/PU)

ETRTO	Version	Article	Article	Article	Article	Article	Article	Article	Article	g
26"										
47-559->62-559	MTB			0180581		0180521	0180551			205
26" (27.5")										
37-559->47-597	Tour					0180621				175
	Tour Hermetic Plus					0180751				255
27.5"										
47-584->62-584	MTB						0182351			230
28" / 29"										
18-622->25/630	Race						0180591	0180611	0180024	100
32-622->47-642	Tour			0180691		0180651	0180681			165
	Tour Hermetic Plus			0180721		0180711				225
47-622->62-622	MTB						0182361			235



Auto Schrader



Blitz Dunlop



Scalverand Presta



Scalverand Presta



Scalverand Presta

ETRTO	Version	A34	A34 45'	A40	D26	D40	S42	S60	S80	g
ETRTO	Version	Article	Article	Article	Article	Article	Article	Article	Article	g
Race 26"										
20-559->25-571							0181371	0181381		95
	Light						0181391	0181411		65
	Supersonic						0181421	0181431		50
Race 28"										
20-622->25-630							0181781	0181791	0180000	100
	Light						0181821	0181831	0181871	65
	Supersonic						0181881	0181891		50
25-622->32-630	Wide						0181921	0181931		125
Cross 28"										
32-622->47-622							0181941	0181951		160
MTB 26"										
47-559->62-559			0181611		0181621	0181631	0181671			205
47-559->60-559	Light					0181681				125
47-559->55-559	Supersonic					0181691				100
57-559->70-559	Freeride		0181721			0181731				295
	Downhill		0181771							535
MTB 27.5"										
47-584->62-584			0182331			0182311				230
47-584->60-584	Light					0182341				145
65-584->70-584	Wide		0180017			0180015				345
	Wide Light					0180019				275
MTB 29"										
47-622->62-622			0182171			0182181	0182191			230
47-622->60-622	Light					0182321	0182201			190
65-622->70-622	Wide		0180031			0180034				345
Tour 26"										
28-559->32-597	Slim				0181471	0181481				145
37-559->47-590	All		0181491		0181511	0181521				175
47-559->62-559	Wide		0181531		0181571	0181591				200
Tour 28"										
28-622->37-622/32-630	Slim		0181971		0181981	0181991				140
32-622->47-622/42-635	All		0182001		0182021	0182031	0182041			165
	Light		0182051		0182061	0182071				115
47-622->62-622	Wide		0182121		0182131	0182161				230
Hermetic Plus										
ETRTO	Version	Article	Article	Article	Article	Article	Article	Article	Article	g
Compact 20"										
32-406->47-451		0180037			0180039					190
50-406->62-406	Wide	0180042			0180045					230
Compact 24"										
32-507->47-544			0182231		0182241					235
55-507->62-507	Wide		0182581							370
Tour 26"										
37-559->47-590	All		0182251		0182261	0182271				255
47-559->62-559	Wide				0181581					300
Tour 28"										
32-622->47-622/42-635	All		0182101		0182081	0182091				225
47-622->62-622	Wide				0182151					325
Compact Tubes										
ETRTO	Version	Article	Article	Article	Article	Article	Article	Article	Article	g
Compact 8"										
54-110					0180991					70
Compact 10" / 11" / 12"										
44-194->62-222		0181051	0182211		0181071					95
Compact 14"										
32-279->47-298					0181081					100
Compact 16"										
32-305->47-349		0181091			0181111	0181121				110
50-305->62-305	Wide	0181131			0181171					120
Compact 18"										
32-355->47-400			0180026	0181181						125
Compact 20"										
28-406->32-451	Slim					0181191				105
32-406->47-451		0181211				0181221	0181231			135
50-406->62-406	Wide	0181271				0181281				155
Compact 24"										
32-507->47-544			0181291		0181311	0180027				155
50-507->60-507	Wide		0181321		0181331					195

TIRES & SIZES

12"	42-559	58-559	50-584
62-203	CONTACT Speed	Cross King ShieldWall	CONTACT Urban
RIDE Tour	47-559	Cross King	CONTACT Speed
16"	Hometrainer II	60-559	55-584
35-349	Mud King ProTecton	Der Kaiser Projekt Apex	Trail King ProTecton Apex
CONTACT Urban	Town&Country	Der Kaiser Projekt ProTecton Apex	Trail King ShieldWall
47-305	CONTACT Plus	Der Baron Projekt ProTecton Apex	Cross King ProTecton
DoubleFighter III	CONTACT Plus City	Trail King ProTecton Apex	Cross King RaceSport
Explorer	CONTACT Plus Travel	Trail King ShieldWall	Cross King ShieldWall
RIDE Tour	CONTACT	Trail King	Cross King
20"	CONTACT Urban	62-559	Race King ProTecton
28-406	CONTACT Travel	Der Kaiser Apex	Race King RaceSport
CONTACT Speed	RIDE Tour	Der Baron Apex	Race King ShieldWall
32-406	RIDE City	26/27.5"	Race King
CONTACT Urban	50-559	37-584	Speed King RaceSport
37-406	Cross King ShieldWall	RIDE Tour	CONTACT Plus City
CONTACT	Cross King	42-584	CONTACT Urban
42-406	Race King ShieldWall	RIDE Tour	57-584
CONTACT Urban	Race King	54-584	Mud King Apex
47-406	DoubleFighter III	RIDE Tour	58-584
DoubleFighter III	Traffic II	27"	Mountain King ProTecton
Explorer	Top CONTACT II	28-630	Mountain King ShieldWall
CONTACT Plus	Top CONTACT Winter II Premium	Super Sport Plus	Mountain King
CONTACT	CONTACT Plus Travel	32-630	Cross King ProTecton
RIDE Tour	CONTACT Urban	Gator Hardshell	Cross King RaceSport
50-406	CONTACT Travel	Gatorskin	Cross King ShieldWall
Cross King	CONTACT Speed	Ultra Sport III	Cross King
CONTACT Plus	CONTACT Cruiser	Super Sport Plus	60-584
CONTACT Urban	RIDE Cruiser	RIDE Tour	Der Kaiser Projekt Apex
CONTACT Cruiser	54-559	37-609	Der Kaiser Projekt ProTecton Apex
55-406	Vapor	RIDE Tour	Der Baron Projekt ProTecton Apex
CONTACT Plus	Explorer	27.5"	Trail King ProTecton Apex
CONTACT Plus City	Traffic II	25-584	Trail King ShieldWall
62-406	Town&Country	Grand Prix 5000	Trail King
CONTACT Plus	55-559	Ultra Sport III	CONTACT Cruiser
24"	Trail King ProTecton Apex	28-584	65-584
47-507	Trail King ShieldWall	Grand Prix 5000	Der Baron Projekt ProTecton Apex
DoubleFighter III	Cross King ProTecton	Grand Prix 5000 Tubeless	Trail King ProTecton Apex
Explorer	Cross King RaceSport	Ultra Sport III	Trail King ShieldWall
Traffic II	Cross King ShieldWall	32-584	Mountain King ProTecton
CONTACT Plus	Cross King	CONTACT Speed	Mountain King ShieldWall
RIDE Tour	Race King ProTecton	35-584	Cross King ProTecton
50-507	Race King RaceSport	Terra Speed ProTecton	Cross King ShieldWall
Cross King	Race King ShieldWall	40-584	70-584
DoubleFighter III	Race King	Terra Trail ProTecton	Trail King ProTecton Apex
55-507	Speed King RaceSport	Terra Speed ProTecton	Trail King ShieldWall
CONTACT Plus City	Top CONTACT Winter II Premium	42-584	Mountain King ProTecton
26"	CONTACT Plus City	CONTACT Plus	Mountain King ShieldWall
23-571	CONTACT Urban	CONTACT Urban	Cross King ProTecton
Grand Prix	CONTACT Cruiser	47-584	Cross King ShieldWall
Gatorskin	RIDE Cruiser	Terra Trail ShieldWall	28"
26 x 19	57-559	Mud King ProTecton	20-622
Competition	Mud King Apex	50-584	Grand Prix Supersonic
26 x 22	Gravity	Hometrainer II	23/25-622
Competition	Vertical	Cross King ShieldWall	Set Grand Prix Attack & Force III
Sprinter	58-559	Cross King	23-622
28-559	Mountain King ProTecton	Race King ShieldWall	Grand Prix Attack III
Grand Prix	Mountain King ShieldWall	Race King	Grand Prix 5000
Gatorskin	Mountain King	DoubleFighter III	Grand Prix TT
32-559	Cross King ProTecton	Top CONTACT II	Grand Prix Supersonic
CONTACT Speed	Cross King RaceSport	Top CONTACT Winter II Premium	Grand Prix 4-Season

23-622
Grand Prix 4-Season Black Edition
Grand Prix
Gator Hardshell
Gator Hardshell Black Edition
Gatorskin
Gatorskin Black Edition
Grand Sport Race
Grand Sport Extra
Ultra Sport III
Hometrainer II
Super Sport Plus
25-622
Grand Prix Force III
Grand Prix 5000
Grand Prix 5000 Tubeless
Grand Prix TT
Grand Prix 4-Season
Grand Prix 4-Season Black Edition
Grand Prix GT
Grand Prix
Grand Prix Classic
Gator Hardshell
Gator Hardshell Black Edition
Gatorskin
Gatorskin Black Edition
Grand Sport Race
Grand Sport Extra
Ultra Sport III
Super Sport Plus
28-622
Grand Prix 5000
Grand Prix 5000 Tubeless
Grand Prix 4-Season
Grand Prix 4-Season Black Edition
Grand Prix GT
Grand Prix
Gator Hardshell
Gator Hardshell Black Edition
Gatorskin
Gatorskin Black Edition
Grand Sport Race
Grand Sport Extra
Ultra Sport III
Hometrainer II
Top CONTACT II
CONTACT Plus
Super Sport Plus
CONTACT
CONTACT Urban
CONTACT Speed
RIDE Tour
28 x 19
Competition
Podium TT
Olympic II
Tempo II
28 x 22
Attack Comp
Competition
Grand Prix 4000 S II Tubular
Podium TT
Sprinter

28 x 22
Sprinter Gatorskin
Giro
Tempo II
28 x 22/24
Set Attack Comp & Force Comp
28 x 23
Sonderklasse II
28 x 24
Force Comp
28 x 25
Competition
Podium TT
Sprinter
Sprinter Gatorskin
30-622
Grand Prix 5000
Grand Prix 5000 Tubeless
32-622
Grand Prix 5000
Grand Prix 5000 Tubeless
Grand Prix 4-Season
Grand Prix 4-Season Black Edition
Gator Hardshell
Gator Hardshell Black Edition
Gatorskin
Gatorskin Black Edition
Grand Sport Race
Grand Sport Extra
Ultra Sport III
Hometrainer II
Cross King CX RaceSport
Mountain King CX RaceSport
Speed King CX RaceSport
Top CONTACT II
CONTACT Plus
CONTACT
CONTACT Urban
CONTACT Speed
CONTACT Spike 120
RIDE Tour
RIDE City
35-622
Grand Prix Urban
Urban TaraxaGum
Terra Speed ProTecton
Terra Trail ShieldWall
Cross King CX Performance
Mountain King CX Performance
Speed King CX Performance
Race King CX Performance
CONTACT Urban
CONTACT Speed
37-622
DoubleFighter III
Top CONTACT II
Top CONTACT Winter II Premium
CONTACT Plus
CONTACT Plus City
CONTACT Plus Travel
CONTACT

37-622
CONTACT Urban
CONTACT Travel
CONTACT Speed
CONTACT Spike 120
CONTACT Spike 240
RIDE Tour
RIDE City
RIDE Classic
37-635
RIDE Tour
40-622
Terra Trail ProTecton
Terra Speed ProTecton
Terra Trail ShieldWall
CONTACT Plus
CONTACT Urban
40-635
RIDE Classic
42-622
Top CONTACT II
Top CONTACT Winter II Premium
CONTACT Plus
CONTACT Plus City
CONTACT Plus Travel
CONTACT
CONTACT Urban
CONTACT Travel
CONTACT Speed
CONTACT Spike 120
CONTACT Spike 240
RIDE Tour
RIDE City
RIDE Classic
Speed RIDE
AT RIDE
42-635
CONTACT Plus
RIDE Tour
47-622
Top CONTACT II
CONTACT Plus
CONTACT Plus City
CONTACT Plus Travel
CONTACT
CONTACT Urban
RIDE Tour
RIDE City
50-622
CONTACT Urban
CONTACT Travel
CONTACT Cruiser
RIDE Cruiser

55-622
CONTACT Urban
CONTACT Cruiser
RIDE Cruiser
29"
47-622
Mud King ProTecton
50-622
Cross King ShieldWall
Cross King
Race King ShieldWall
Race King
DoubleFighter III
55-622
Trail King ProTecton Apex
Trail King ShieldWall
Cross King ProTecton
Cross King RaceSport
Cross King ShieldWall
Cross King
Race King ProTecton
Race King RaceSport
Race King ShieldWall
Race King
Speed King RaceSport
57-622
Mud King Apex
58-622
Mountain King ProTecton
Mountain King ShieldWall
Mountain King
Cross King ProTecton
Cross King RaceSport
Cross King ShieldWall
Cross King
60-622
Der Kaiser Projekt Apex
Der Kaiser Projekt ProTecton Apex
Der Baron Projekt ProTecton Apex
Trail King ProTecton Apex
Trail King ShieldWall
Trail King
65-622
Trail King ProTecton Apex
Trail King ShieldWall
Mountain King ProTecton
Mountain King ShieldWall
Cross King ProTecton
Cross King ShieldWall



ACCESSORIES

RIMSTRIP

The non visible component, but with a huge effect. A missing or badly chosen rim tape is the cause of many punctures. For rims with spoke holes it is particularly important to use a tape that remains stable under pressure and one which covers the entire rim base. The fabric-reinforced Continental EasyTape was specially developed for use under high pressure conditions. Various widths allow a perfect fit to be achieved in all common rim types. The high pressure version for racing bikes can withstand pressures up to 220 PSI without deformation. Its wafer-thin profile also allows the tire to be mounted much easier.



Mounting

Article	Product	Version	PU
0140095	Mounting pads	3 pcs	3

Tire fitting/removing lever

Article	Version	PU
0149090	MTB/Tour	50
0149093	Road	50

Easy Tape Rim Strip < 116 PSI

Article	ETRTO	Version	PU
0195031	18-559	Set Box 2 pcs	1
0195000	20-559	Set Box 2 pcs	1
0195002	22-559	Set Box 2 pcs	1
0195006	24-559	Set Box 2 pcs	1
0195009	26-559	Set Box 2 pcs	1
0195035	18-584	Set Box 2 pcs	1
0195038	20-584	Set Box 2 pcs	1
0195043	22-584	Set Box 2 pcs	1
0195048	24-584	Set Box 2 pcs	1
0195049	26-584	Set Box 2 pcs	1
0195027	14-622	Set Box 2 pcs	1
0195013	18-622	Set Box 2 pcs	1
0195015	20-622	Set Box 2 pcs	1
0195018	22-622	Set Box 2 pcs	1
0195022	24-622	Set Box 2 pcs	1
0195025	26-622	Set Box 2 pcs	1

Easy Tape Tubeless

Article	Width	Version	PU
0195109	23 mm	33 m	1
0195103	23 mm	5 m	1
0195110	25 mm	33 m	1
0195104	25 mm	5 m	1
0195112	27 mm	33 m	1
0195105	27 mm	5 m	1
0195113	29 mm	33 m	1
0195107	29 mm	5 m	1

Easy Tape Rim Strip High Pressure < 220 PSI

Article	ETRTO	Version	PU
0195066	16-622	Set 2 pcs	1
0195070	18-622	Set 2 pcs	1

Rubber Rim Strip < 70 PSI

Article	Version	PU
0194000	12 1/2" [203 mm] 20 mm	50
0195004	16" [305 mm] 16 mm	50
0195012	20" [406 mm] 16 mm	50
0195016	20" [406 mm] 20 mm	50
0195024	22-24" [489-540 mm] 14 mm	50
0195045	26-28" [559-635 mm] 20 mm	50

See also page 19

Tubeless Ready Set | Tape | Valves | Sealant

Article	Version	PU
0140092	25 mm	5
0140093	27 mm	5
0140094	29 mm	5

Tubeless Ready Set

contains:

- 1x Conti RevoSealant 240 ml
- 1x Tubeless rim tape
- 2x Tubeless S42 valves
- 3x Tire levers
- 3x Mounting pads
- 1x Mounting instruction





CONTI REVOSEALANT

Punctures and small cuts? The ammonia and protein-free RevoSealant reliably seals holes without attacking the tire or tube chemically.

RevoSealant was developed specifically for our MTB TR and Road TL systems. In addition it effectively prevents punctures and repairs tubulars and tubes.

Continental RevoSealant

Article	Version	PU
0140050	1000 ml	6
0140044	240 ml	20
0140089	60 ml	12

VALVE EXTENSIONS

We offer a valve extension for every type of rim. What is required is a tube with a Presta valve which has an interchangeable insert. With the enclosed tool you can easily fit the valve extension yourself.

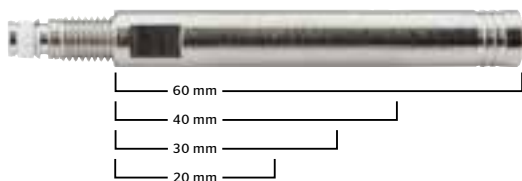

Valve extension Aluminium for presta valve

Article	Version	PU
0140028	20 mm Set 2 pcs	2
0140030	30 mm Set 2 pcs	2
0140032	40 mm Set 2 pcs	2
0140034	60 mm Set 2 pcs	2



Bag with tube and 2 tire levers

Article	Version	PU
0101025	MTB 27.5" S42	1
0101026	MTB 29" S42	1
0100385	MTB 26" S42	1
0100388	Race 28" S42	1
0100384	Race 28" S60	1
0100448	Tour 28" D40	1



Valves & Co

Article	Version	PU
0140090	Tubeless Valves Set S40	10



Rim Cement

Article	Product	Version	PU
0140017	Carbon	200 g can	1
0140016	Carbon	12 tubes with 25 g each	12
0149092	Aluminium	350 g can	1
0149091	Aluminium	12 tubes with 25 g each	12

POS Merch

Repair blocks Continental

Article	Color	Size	PU
1796101		Box 50 pcs	1



Key ring pendant

Article	Color	Size	PU
1795783	yellow		1



Aluminium sign BlackChilli, rectangular

Article	Color	Size	PU
1795359	black	68 x 21 cm	1



Logo Conti, PVC

Article	Color	Size	PU
1791020	black	240 x 90 cm	1
1791021	yellow	240 x 90 cm	1

Logo „deutsche technik“

Article	Color	Size	PU
1791022		240 x 90 cm	1



Sticker set, different sizes

Article	Color	Size	PU
1795662	black	Set 120 pcs	1



Sticker set, different sizes

Article	Color	Size	PU
1795663	yellow	Set 120 pcs	1



Beachflag

Article	Color	Size	PU
1795725		2,75 m	1
(incl. 9 kg bottom plate, high-value rotary base and flag)			



Director's chair

Article	Color	Size	PU
1799546	black		1



Drinking flask

Article	Color	Size	PU
0149601			1



Trucker Cap

Article	Color	Size	PU
1795794	black	One Size	1



MTB Fender Baron Projekt

Article	Color	Size	PU
1795782			1



Mechanic's gloves, 1 pair

Article	Color	Size	PU
1795585	black	M	1
1795586	black	L	1
1795587	black	XL	1



Pinafore

Article	Color	Size	PU
1795538	black		1



Waist apron

Article	Color	Size	PU
1795539	black		1

POS Shop

An attractive and clear presentation of products is crucial in retail.

Wire bead bicycle tires for example, should be presented in a hanging position due to their big dimensions, in order to be properly perceived by your customers. But in fact, only very few convincing solutions for high-quality tires are available in the market.

By CONTI™-Shop-System-Combinations we offer you a variety of customizable ways to present tires in your shop - for wire bead tires as well as for foldable tires and tubes! Learn more about possible combinations from your Continental contact person.

CONTI™-Shop-Combination

3 x 125 cm elements

Article	Product	Quantity
1791059	Post	4
1791060	Rear panel	3
1791062	Top sign	3
1791065	Display rail	9
1791064	Tire support	14
1791068	Accessory shelf	1
1791070	Tube shelf	1
1791072	Extension	3
1791067	Euro hooks (7 pc.)	1
1795661	Signage	1





**ALSO IN
66,5 cm**



**ALSO IN
66,5 cm**

Display wired-on tires combination

Width 125 cm

Article	Product	Quantity
1791059	Post	2
1791060	Rear panel	1
1791062	Top sign	1
1791065	Display rail	4
1791064	Tire support	4
1791068	Accessory shelf	1
1791070	Tube shelf	1
1795661	Signage	1

Display folding tires combination

Width 125 cm

Article	Product	Quantity
1791059	Post	2
1791060	Rear panel	1
1791062	Top sign	1
1791065	Display rail	3
1791064	Tire support	2
1791068	Accessory shelf	1
1791070	Tube shelf	1
1791067	Euro hooks (7 pc.)	2
1795661	Signage	1



**GONDOLA
"DUO"
ALSO IN
66,5 cm**

Gondola base

Width 125 cm

Article	Product	Quantity
1795765	Base	1
1795767	Rear panel	1
1795770	Flag	2
1791070	Tube shelf	1
1791065	Display rail	1
1791064	Tire support	2

-> Also available as Gondola DUO in 66,5 cm and 125 cm (stand-alone in the room)

TECH SUPPORT

Mounting instruction Grand Prix 5000 TL



TIPS AND TRICKS

In individual cases where the tire bead does not properly sit on the inside of the rim, try unscrewing the valve nut and pushing the valve back.

Valves with a round rubber end have a lower volume than those with a rectangular rubber end. Maybe you could try to change your existing valve to fit your tire accordingly.

WATCH THE VIDEO



RECOMMENDED AMOUNTS OF SEALANT PER TIRE

ROAD	<i>Dimension</i>	<i>Filling amount</i>
	25 mm	30 - 60 ml
	28 mm	60 - 90 ml

MTB	<i>Dimension</i>	<i>Filling amount</i>
	2.0 - 2.1	80 - 100 ml
	2.2 - 2.3	100 - 120 ml
	2.4 - 2.5	120 - 150 ml
	2.6 - 2.8	150 - 180 ml

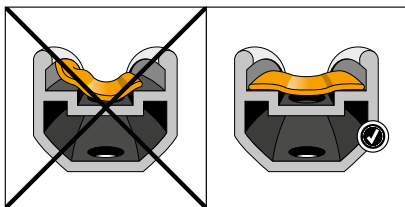

1 Check both rim and rim tape. Only use Tubeless ready rims. Ensure that the rim tape covers the rim well with at least two layers.

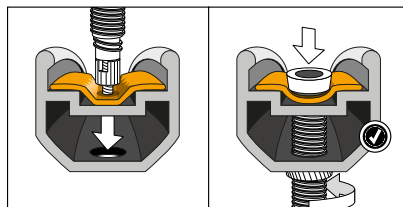

2 Mount the Tubeless valve first. Install it from the inside of the rim and tighten the nut. Press your finger on the rubber end of the valve to secure a better fit. Only tighten the nut by hand, do not use any tools.

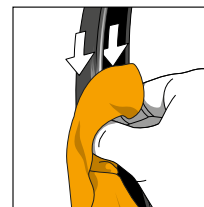

3 Before the initial inflation you can apply some soapy-water or a mounting pad on the contact points between tire and rim bed. This can help improve mounting the tire on the rim.

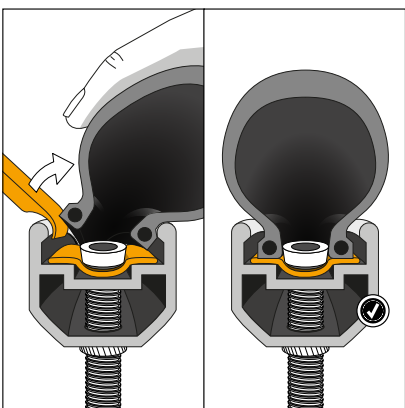

4 Mount the Tubeless tire on the rim in correct orientation of rotation. Ensure no loose pieces (e.g. sand, plastics) are found inside. Due to the tighter dimension tolerances of a Tubeless tire compared to a normal Clincher tire it may be helpful for you to use tire levers.

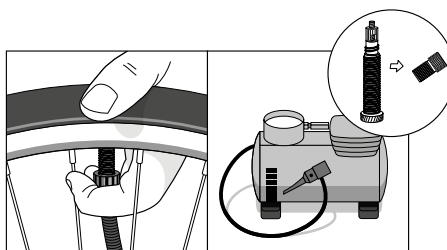

5 To fit the tire between the hooks, you may need a higher amount of air in the first instance. If you are using a floor pump, it is better to maintain a constant momentum within the first few seconds. A modern floor pump with a second inflatable cartridge can help to achieve this.

If a floor pump does not fill and accurately seat the tire, a compressor could help. You may need to adapt to the respective bicycle valve.

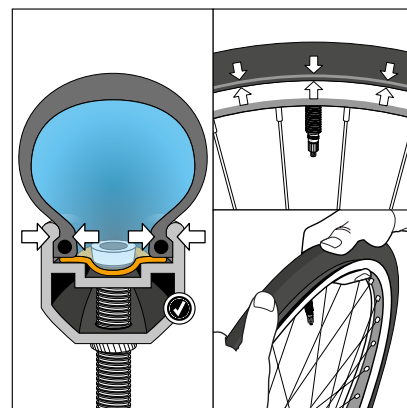

6 The correct fitting of the tire on the rim is mostly notable by a loud clicking noise. Check the air tightness of your Tubeless system. Does it lose any air? Check if the control line has an equal distance to the rim. If not release some air and work on the tire with both hands.

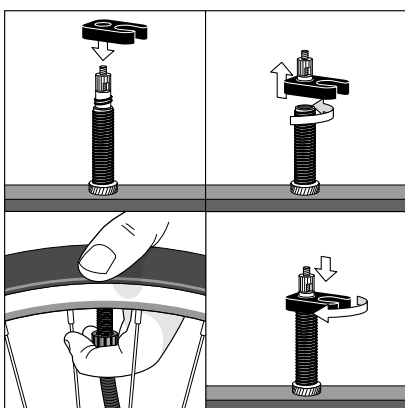

7 To enhance the air volume, unscrew the valve core. Pump it up and screw the valve core in again.

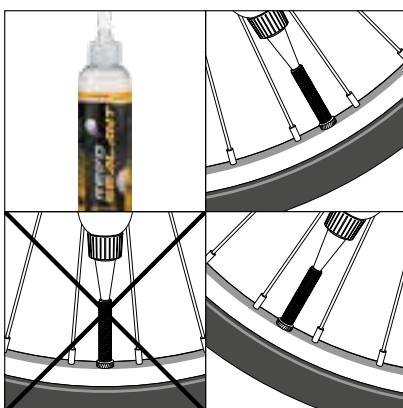

8 For the best puncture resistance, we recommend to fill approximately 30 - 60 ml of tire sealant through the valve. Considering it will dry over time, it is best to check and refill it every 3 - 6 months.

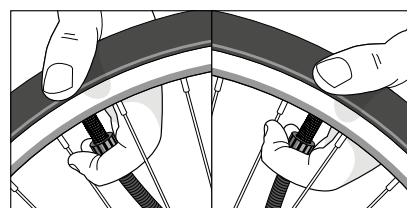

9 If you are using tire sealant: For inflation place the tire with the valve at the 11 or 1 o'clock position. Otherwise sealant could leak into the valve or put too much turbulence into it. It could dry faster or lock up the valve core.

Please be advised that the use of a CO2 cartridge can clump the sealant particles.

Important:
Do not insert the tire sealant with the valve at a 6 o'clock position! The valve should be located at the 5 or 7 o'clock position.

MADE IN GERMANY

Passion and Technology.





Producing the best tires is just ok for us. That's why our designers and engineers are always working continuously to make our products even more efficient, developing new or improved formulations for our rubber compounds for example. These changes are not always visible at first glance, but they are definitely noticeable.

**Ride the difference,
ride "handmade in Germany".**

Continental is the only German bicycle tire manufacturer to produce its tires in Germany. Knowing this serves as a mighty incentive to our engineers and everyone else involved in the manufacturing process to constantly strive for further innovations.

"Handmade in Germany" denotes that the tires are produced in our technology and development center in Korbach, mostly by hand and with a high proportion of manual labor from tire design to the final quality control. For you this means offering your customers tires with German technology - a tradition since 1871.

We are constantly developing new revolutionary technologies such as the unbeatable BlackChili Compound and the ultimate Vectran™ breaker anti-puncture technology, both used at the top end of race sport. These technologies demand sophisticated processes to ensure our legendary end-product quality, and these innovations as well as the ProTection and RaceSport technology for MTB tires, can only be manufactured in our factory in Germany - "Handmade in Germany".

In order to offer the best tire for any application, we rely equally on dialogue with our professional racers, hobby cyclists and everyday bike riders.



As a global player, Continental also maintains high-tech production facilities outside of Germany, where Continental tires are produced for you with an equal degree of care and dedication. Our heart and soul is behind the phrase "Handmade in Germany", with all of its products and technologies. punctures thanks to thicker material.



Newsletter for wholesale and retail



Subscribe here
with QR Code

Continental on Social Media



www.facebook.com/ContiBicycleTires



www.instagram.com/conti_road



www.instagram.com/conti_mtb



www.instagram.com/conti_urban

Continental Reifen Deutschland GmbH

Bicycle Tire Division
Continentalstraße 3-5
D-34497 Korbach

www.conti-bicycletires.com

Subject to technical changes. No reliability for
printer's error:
06/20 Barthelmay & Habedank Design GmbH.

Vectran™ is the registered trademark of Kuraray
Co., Ltd.; Kevlar® is the registered trademark of
E. I. du Pont de Nemours and Company.

© Copyright 2020 by
Continental Reifen Deutschland GmbH,
30165 Hannover, Germany.

Continental 
The Future in Motion