



# TECH INFO

## BICYCLE TIRES

FACTS

KNOWLEDGE

TECHNOLOGY

TIPS

<b>Tire Sizes</b>	<p>5 Tire Construction</p> <p>6 What components make up a tire?</p> <p>8 How is a bicycle tire manufactured?</p> <p>8 Where are Schwalbe tires manufactured?</p>
<b>Tire Dimensions</b>	<p>9 Why are tires often narrower than the stated tire size?</p> <p>9 Will the tire fit into my frame?</p> <p>10 Which tire fits which rim?</p> <p>10 What is the exact circumference of my tire?</p>
<b>Tire Construction</b>	<p>11 What components make up a tire?</p> <p>12 How is a bicycle tire manufactured?</p> <p>13 Where are Schwalbe tires manufactured?</p> <p>13 What is the reason for Schwalbe manufacturing their tires in Indonesia?</p> <p>14 What are the working conditions in the Schwalbe production facilities?</p> <p>14 What does EPI mean in relation to the carcass?</p> <p>15 Does a perfect rubber compound exist?</p> <p>15 Why are reflective lines used?</p>
<b>Tire Types</b>	<p>16 What is a clincher tire?</p> <p>16 What is a folding tire?</p> <p>16 What is a tubular?</p> <p>17 What is a tubeless tire?</p> <p>17 What does Tubeless Ready or Tubeless Easy mean?</p> <p>18 What is the difference compared to normal tires?</p>
<b>Tread</b>	<p>19 What does the tire tread do?</p> <p>19 Why ride a slick tire?</p> <p>19 What do the direction arrows mean?</p> <p>19 Why are so many treads direction dependant?</p>
<b>Rolling Resistance</b>	<p>20 What exactly is rolling resistance?</p> <p>21 Which factors affect rolling resistance?</p> <p>22 Why do wide tires roll better than narrower tires?</p> <p>22 Why do professional road racers use narrow tires?</p>
<b>Puncture Protection</b>	<p>23 How can a puncture be prevented?</p> <p>23 Which is the best puncture protection belt?</p> <p>24 How should puncture protection liquids be used?</p>
<b>Tire Wear</b>	<p>25 When is a tire worn out?</p> <p>25 What mileage can be achieved with various tires?</p> <p>26 Why do many tires wear prematurely?</p> <p>27 Why do tires of multi-track vehicles often wear down so fast?</p> <p>27 How long can a tire be stored?</p>
<b>Tube</b>	<p>28 What is a bicycle tube made of?</p> <p>28 Which special features does a Schwalbe tube offer?</p> <p>29 What are the advantages of latex tubes?</p>

<b>Valve</b>	30	Which is the best valve?
	30	What is the purpose of a rim nut?
	31	What causes a valve tear off?
	31	What can be done to prevent tire slip or a valve tear off?
<b>Fitting</b>	32	How is a bicycle tire fitted?
	33	Why is it sometimes so difficult to fit a tire?
	33	What can be done if it is difficult to fit the tire on the rim?
	34	What can be done if the tire cannot be centered?
	34	What should be considered when fitting onto hookless rims?
	35	How is a tubular tire fitted?
<b>Inflation Pressure</b>	36	Why is the inflation pressure of bicycle tires so important?
	36	How often should the inflation pressure be checked?
	37	What is the correct inflation pressure for my tire?
<b>Rim Tape</b>	38	What does a rim tape do?
	38	Which rim tape should I use?
	38	Why doesn't Schwalbe offer a 12 mm high-pressure rim tape?
<b>Tubeless</b>	39	What are the advantages of a tubeless tire?
	39	What do you need to fit a tire without a tube?
	40	What do you have to keep in mind for the fitting?
	40	Do I have to fill in the fluid through the valve?
	41	Why do you need puncture protection liquid?
	41	What can be the reason if the tire cannot be inflated?
	41	Further reasons for what can go wrong.
	42	Is it possible to retrofit normal wheels for the fitting of tubeless tires?
	42	Which wheels are suitable for the conversion?
	43	What do you have to keep in mind for the tubeless conversion?
	43	How often do I have to refill or replace the sealing liquid?
	43	What to do in case of a puncture?
<b>E-Bike</b>	44	Do you need special tires for e-bikes?
	44	What to bear in mind with speed e-bikes.
	44	There are some Marathon sizes with the ECE-R75 mark of conformity. What are the differences between Energizer and Marathon?
<b>Winter Tires</b>	45	What is the reason for Schwalbe only offering winter tires with spikes?
	45	Things you should know about spiked tires.
<b>Balloonbike</b>	46	What is a balloonbike?
	46	What are the advantages in contrast to a full suspension?
	47	What is the intended use of a balloonbike?
	47	Can I fit wide tires on a normal bicycle?
<b>Special Issues</b>	48	Is there a connection between tires and a wobble?
	48	Why do some tires leave discolorations on plastic floor coverings?
	49	Does it make any sense to deflate tires for transport by air?
<b>History</b>	49	Who actually invented the bicycle tire?
	49	What is the origin of the name Schwalbe?

Dear Reader,

This booklet is not meant as a scientific paper with detailed technical specifications. It is rather an attempt to give short, precise and helpful answers to questions about bicycle tires that have been put to us time and again.

We will not detail state-of-the-art technologies and precise product specifications as this booklet will not be updated every year. The first version dates from the year 2003. The present booklet is the 3rd edition revised in 2014. In the last version we were quite critical with regard to tubeless tires. This view has changed considerably due to our own development work. In our opinion this technology provides a great potential for all ambitious cyclists and this is the reason why it takes up so much space in the present booklet.

I myself am not a technician, but responsible for communications at Schwalbe. At the same time, I am an intensive user of our products and have a lot of fun in cycling and in optimizing my bicycles. To that end, I wish you much pleasure in reading and afterwards all the more fun on your bicycle.

Carsten Zahn  
Head of Marketing



## What do the various size specifications on bicycle tires mean?

Nowadays, bicycle tire sizes are all marked according to ETRTO (European Tire and Rim Technical Organization) standard. However, older English and French tire size dimensions are still used as well.

The ETRTO size specification 37-622 indicates the width of 37 mm and the tire inner diameter of 622 mm. This dimension is clear and allows a precise classification of the rim size.

The **inch marking** (e.g. 28 x 1.40) states the approximate outer diameter (28 inches) and the tire width (1.40 inches). Another inch marking is 28 x 1  $\frac{5}{8}$  x 1  $\frac{3}{8}$  (approximate outer diameter x tire height x tire width); it is also common.

Inch sizes are not precise and lack accuracy. For example, diameters 559 mm (MTB), 571 mm (Triathlon) and 590 mm (Touring) are all classified as 26 inch. Tires with diameters 622 mm and 635 mm are both classified as 28 inch. Oddly enough, tires with an inner diameter of 630 mm are classified as 27 inch.

These classifications originate from the time of tire brakes. In those days, the exact outer diameter of the tire was defined by the brake. Depending on tire width, various standards for the inner diameter applied.

Inch dimensions are widely used in both MTB sport and English language countries. Therefore, we will continue to use these specifications for all tires. But only in decimal form, e.g. 26 x 2.25. Experience tells us that nowadays very few users are familiar with the classical fractional inch dimensions, such as 28 x 1  $\frac{5}{8}$  x 1  $\frac{3}{8}$ .

When the 29 inch MTB tire size was introduced a few years ago, it had the same inner diameter of 622 mm, known as 28 inch in Europe.

The latest tire size is 27.5 inches. This tire size is favored for MTBs which are too small for the very big 29 inch wheels, in order to benefit from the advantages of bigger diameters. This is the case, for example, with bicycles having a very long suspension travel or very small frame sizes. 27.5 inch tires have an inner diameter of 584 mm and are identical with the old French size marking 650B.

French size markings (e.g. 700 x 35C) give the approximate tire outer diameter (700 mm) and width (35 mm). The letter at the end indicates the inner diameter of the tire. In this case, C stands for 622 mm. French size markings are not used for all tire sizes, so, for example, it is not used for MTB sizes.



	ETRTO	Inches	French
<b>Size marking</b>	37-622	28 x 1.40 28 x 1 $\frac{5}{8}$ x 1 $\frac{3}{8}$	700 x 35C
<b>Outer diameter</b>	-	ca. 28 inch	ca. 700 mm
<b>Inner diameter</b>	622 mm	-	-
<b>Tire width</b>	ca. 37 mm	ca. 1 $\frac{5}{8}$ inch bzw. 1.40 inch	ca. 35 mm
<b>Tire height</b>	-	ca. 1 $\frac{5}{8}$ inch	-

## How many tire sizes are there?

The following list shows all common tire sizes. For virtually every tire size, you should be able to find a corresponding ETRTO-size in this list.

The current Schwalbe sizes and markings are given in bold. We have tried to list in addition all tire sizes which are currently used on the market or which were used in the past. These classical fractional size indications are also often engraved on old Schwalbe tires. Sometimes, you still find them on current models which have already been available for quite a long time.

	ETRTO	Inches	French
<b>12"</b>	<b>47-203</b>	<b>12 x 1.75</b>	
		12 x 1.90	
		12 ½ x 1.75	
		12 ½ x 1.90	
	<b>50-203</b>	<b>12 x 2.00</b>	
	54-203	12 x 1.95	
	57-203	12 ½ x 2 ¼	
<b>62-203</b>	<b>12 ½ x 2 ¼</b>		
<b>14"</b>	47-254	14 x 1.75	
		14 x 1.90	
	<b>50-254</b>	<b>14 x 2.00</b>	
	40-279	14 x 1 ½	350 x 38B
	<b>37-288</b>	<b>14 x 1 ¾</b>	<b>350 x 35A</b>
		14 x 1 ¾ x 1 ¾	
	40-288	14 x 1 ¾	350 x 38A
	44-288	14 x 1 ¾ x 1 ¾	350 x 42A
	<b>47-288</b>	<b>14 x 1.75</b>	
	32-298	14 x 1 ¼	350 x 32A
<b>16"</b>	<b>40-305</b>	<b>16 x 1.50</b>	
	<b>47-305</b>	<b>16 x 1.75</b>	
		16 x 1.90	
	<b>50-305</b>	<b>16 x 2.00</b>	
	54-305	16 x 1.95	
		16 x 2.00	
	<b>57-305</b>	<b>16 x 2.125</b>	
	40-330	16 x 1 ½	400 x 38B
	28-340		400 x 30A
	32-340	16 x 1 ¾ x 1 ¼	400 x 32A
	37-340	16 x 1 ¾	400 x 35A
	44-340	16 x 1 ¾	
	28-349	16 x 1 ½	
	<b>30-349</b>	<b>16 x 1.20</b>	
	<b>32-349</b>	<b>16 x 1 ¼</b>	

	ETRTO	Inches	French
<b>16"</b>		16 x 1.25	
	<b>35-349</b>	<b>16 x 1.35</b>	
	37-349	16 x 1 ¾	
<b>17"</b>	32-357	17 x 1 ¼	
	<b>32-369</b>	<b>17 x 1 ¼</b>	
<b>18"</b>	28-355	18 x 1 ¾	
	<b>32-355</b>	<b>18 x 1.25</b>	
	35-355	18 x 1.35	
	<b>40-355</b>	<b>18 x 1.50</b>	
	<b>42-355</b>	<b>18 x 1.60</b>	
	<b>47-355</b>	<b>18 x 1.75</b>	
		18 x 1.90	
	<b>50-355</b>	<b>18 x 2.00</b>	
	37-387	18 x 1 ½	
	28-390	18 x 1 ¾	450 x 28A
	<b>37-390</b>	<b>18 x 1 ¾</b>	<b>450 x 35A</b>
55-390		450 x 55A	
57-390		450 x 55A	
37-400	18 x 1 ¾		
<b>20"</b>	54-400	20 x 2 x 1 ¾	
	<b>23-406</b>	<b>20 x 0.90</b>	
	25-406	20 x 1.00	
	<b>28-406</b>	<b>20 x 1.10</b>	
		20 x 1 ¾	
	32-406	20 x 1.25	
	<b>35-406</b>	<b>20 x 1.35</b>	
	37-406	20 x 1.40	
		20 x 1 ¾	
	<b>40-406</b>	<b>20 x 1.50</b>	
	<b>42-406</b>	<b>20 x 1.60</b>	
	<b>44-406</b>	<b>20 x 1.50</b>	
	44-406	20 x 1.625	
	<b>47-406</b>	<b>20 x 1.75</b>	

	ETRTO	Inches	French
<b>20"</b>	47-406	20 x 1.90	
	<b>50-406</b>	<b>20 x 2.00</b>	
	<b>54-406</b>	<b>20 x 2.10</b>	
		20 x 2.00	
	<b>55-406</b>	<b>20 x 2.15</b>	
	<b>57-406</b>	<b>20 x 2.25</b>	
		20 x 2.125	
	60-406	20 x 2.35	
	<b>54-428</b>	<b>20 x 2.00</b>	
	40-432	20 x 1 ½	
	<b>37-438</b>	<b>20 x 1 ¾</b>	
	40-438	20 x 1 ¾ x 1 ½	
	28-440		500 x 28A
	37-440		500 x 35A
	40-440	20 x 1 ½ NL	500 x 38A
	<b>23-451</b>	<b>20 x 0.90</b>	
	20 x ¾		
<b>25-451</b>	<b>20 x 1.00</b>		
<b>28-451</b>	<b>20 x 1 ¾</b>		
<b>37-451</b>	<b>20 x 1 ¾ B.S.</b>		
<b>22"</b>	<b>44-457</b>	<b>22 x 1.75</b>	
	<b>44-484</b>	<b>22 x 1 ¾ x 1 ½</b>	
	<b>25-489</b>	<b>22 x 1.00</b>	
	<b>37-489</b>	<b>22 x 1 ¾ NL</b>	
	40-489	22 x 1 ¾ x 1 ½	
	50-489	22 x 2.00	
	28-490		550 x 28A
	32-490	22 x 1 ¾ x 1 ¼	550 x 32A
	<b>37-490</b>	<b>22 x 1 ¾</b>	<b>550 x 35A</b>
	47-498	22 x 1 ¾ x 1 ¼	
	<b>25-501</b>	<b>22 x 1.00 B.S.</b>	
	32-501	22 x 1 ¼	
37-501	22 x 1 ¾		

	ETRTO	Inches	French
<b>24"</b>	<b>40-507</b>	<b>24 x 1.50</b>	
	44-507	24 x 1.625	
		24 x 1.75	
	<b>47-507</b>	<b>24 x 1.75</b>	
		24 x 1.85	
		24 x 1.90	
	<b>50-507</b>	<b>24 x 2.00</b>	
		24 x 1.90	
		24 x 2.125	
	<b>54-507</b>	<b>24 x 2.10</b>	
	<b>55-507</b>	<b>24 x 2.15</b>	
	<b>57-507</b>	<b>24 x 2.25</b>	
		24 x 2.125	
	<b>60-507</b>	<b>24 x 2.35</b>	
	<b>62-507</b>	<b>24 x 2.40</b>	
	<b>23-520</b>	<b>24 x 0.90</b>	
		24 x 7/8	
	44-531	24 x 1 1/8 x 1 1/2	
	40-534	24 x 1 1/2	
	<b>20-540</b>	<b>24 x 3/4</b>	
	<b>23-540</b>	<b>24 x 0.90</b>	
		24 x 7/8	
	<b>25-540</b>	<b>24 x 1.00</b>	
	<b>30-540</b>	<b>24 x 1.20</b>	
	32-540	24 x 1 1/8 x 1 1/4	
	<b>37-540</b>	<b>24 x 1 3/8</b>	
	40-540	24 x 1 3/8 x 1 1/2	
	22-541		
	25-541		600 x 25A
	28-541		600 x 28A
	32-541	24 x 1 3/8 x 1 1/4 NL	600 x 32A
	37-541		600 x 35A
<b>25"</b>	57-520	25 x 2.25	
<b>26"</b>	<b>20-559</b>	<b>26 x 3/4</b>	
	<b>23-559</b>	<b>26 x 0.90</b>	
		26 x 7/8	
	<b>25-559</b>	<b>26 x 1.00</b>	
	<b>28-559</b>	<b>26 x 1.10</b>	
	<b>30-559</b>	<b>26 x 1.20</b>	
	<b>32-559</b>	<b>26 x 1.25</b>	
	<b>35-559</b>	<b>26 x 1.35</b>	
	37-559	26 x 1.40	
		26 x 1 1/8 x 1 1/8	
	<b>40-559</b>	<b>26 x 1.50</b>	
	<b>42-559</b>	<b>26 x 1.60</b>	
	44-559	26 x 1.625	
	<b>44-559</b>	<b>26 x 1.75</b>	
	<b>47-559</b>	<b>26 x 1.75</b>	
		26 x 1.80	
		26 x 1.85	
		26 x 1.90	
	<b>50-559</b>	<b>26 x 2.00</b>	
		26 x 1.90	
		26 x 1.95	
	<b>54-559</b>	<b>26 x 2.10</b>	
		26 x 1.95	
		26 x 2.125	
	<b>57-559</b>	<b>26 x 2.25</b>	

	ETRTO	Inches	French	
<b>26"</b>		26 x 2.125		
		26 x 2.20		
	<b>60-559</b>	<b>26 x 2.35</b>		
	<b>62-559</b>	<b>26 x 2.40</b>		
		26 x 2.50		
	<b>64-559</b>	<b>26 x 2.50</b>		
	65-559	26 x 2.60		
	70-559	26 x 2.75		
	75-559	26 x 3.00		
	95-559	26 x 3.70		
		26 x 3.80		
	<b>100-559</b>	<b>26 x 4.00</b>		
	115-559	26 x 4.50		
	<b>120-559</b>	<b>26 x 4.80</b>		
	20-571	26 x 3/4		
	<b>23-571</b>	<b>26 x 7/8</b>	<b>650 x 23C</b>	
	40-571	26 x 1 1/2 CS 26 x 1 3/8 x 1 1/2 NL	650 x 38C	
	47-571	26 x 1 3/4	650 x 45C	
			650 CS Confort	
	54-571	26 x 2 x 1 3/4	650 x 50C	
	<b>20-590</b>	<b>26 x 3/4</b>	<b>650 x 20A</b>	
	<b>25-590</b>	<b>26 x 1.00</b>	<b>650 x 25A</b>	
	28-590	26 x 1 1/8 x 1 1/8	650 x 28A	
	<b>32-590</b>	<b>26 x 1 1/8 x 1 1/4</b>	<b>650 x 32A</b>	
	<b>37-590</b>	<b>26 x 1 1/8</b>	<b>650 x 35A</b>	
	40-590	26 x 1.50 26 x 1 1/8 x 1 1/2	650 x 38A	
	<b>42-590</b>	<b>26 x 1 1/8</b>	<b>650 x 40A</b>	
	32-597	26 x 1 1/4		
	<b>27"</b>	<b>40-609</b>	<b>27 x 1 1/2</b>	
		20-630	27 x 3/4	
		22-630	27 x 7/8	
		25-630	27 x 1.00 27 x 1 1/16	
		27 x 1 1/8		
<b>32-630</b>		<b>27 x 1 1/4</b>		
35-630		27 x 1 3/8		
<b>27.5"</b>		28-584	26 x 1 1/8 x 1 1/2	650 x 28B
	32-584		650 x 32B	
	<b>35-584</b>	<b>27.5 x 1.35</b>	<b>650B</b>	
		26 x 1 3/8 x 1 1/2	650 x 35B	
	<b>37-584</b>	<b>27.5 x 1.40</b>	<b>650B</b>	
		26 x 1 1/2 x 1 3/8	650 x 35B	
			650 Standard	
	<b>40-584</b>	<b>27.5 x 1.50</b>	<b>650B</b>	
		26 x 1 3/8 x 1 1/2	650 x 38B	
	<b>44-584</b>	<b>27.5 x 1.65</b>	<b>650B</b>	
		26 x 1 3/8 x 1 1/2	650 x 42B	
			650B Semi-Confort	
			650B 1/2 Ballon	
	<b>47-584</b>	<b>27.5 x 1.75</b>	<b>650B</b>	
	<b>50-584</b>	<b>27.5 x 2.00</b>	<b>650B</b>	
	<b>54-584</b>	<b>27.5 x 2.10</b>	<b>650B</b>	
		26 x 1 1/2 x 2		
	<b>57-584</b>	<b>27.5 x 2.25</b>	<b>650B</b>	

	ETRTO	Inches	French	
<b>27.5"</b>	<b>60-584</b>	<b>27.5 x 2.35</b>	<b>650B</b>	
	<b>62-584</b>	<b>27.5 x 2.40</b>	<b>650B</b>	
	<b>64-584</b>	<b>27.5 x 2.50</b>	<b>650B</b>	
	65-584	27.5 x 2.60	650B	
	70-584	27.5 x 2.75	650B	
	74-584	27.5 x 2.90	650B	
	75-584	27.5 x 3.00	650B	
	<b>28"</b>	18-622	28 x 3/4	700 x 18C
		19-622		700 x 19C
				700 x 19
<b>20-622</b>		<b>28 x 3/4</b>	<b>700 x 20C</b>	
<b>22-622</b>		<b>28 x 7/8</b>	<b>700 x 22C</b>	
			700 x 22	
<b>23-622</b>		<b>28 x 0.90</b>	<b>700 x 23C</b>	
		28 x 7/8		
<b>24-622</b>			<b>700 x 24C</b>	
<b>25-622</b>		<b>28 x 1.00</b>	<b>700 x 25C</b>	
		28 x 1 1/16		
<b>26-622</b>			<b>700 x 26C</b>	
<b>28-622</b>		<b>28 x 1.10</b>	<b>700 x 28C</b>	
		28 x 1 1/8 x 1 1/8		
<b>30-622</b>		<b>28 x 1.20</b>	<b>700 x 30C</b>	
<b>32-622</b>		<b>28 x 1.25</b>	<b>700 x 32C</b>	
		28 x 1 1/8 x 1 1/4		
<b>33-622</b>		<b>28 x 1.30</b>	<b>700 x 33C</b>	
<b>35-622</b>		<b>28 x 1.35</b>	<b>700 x 35C</b>	
<b>37-622</b>		<b>28 x 1.40</b>	<b>700 x 35C</b>	
		28 x 1 1/8 x 1 3/8		
<b>40-622</b>	<b>28 x 1.50</b>	<b>700 x 38C</b>		
	28 x 1 1/8 x 1 1/2			
<b>42-622</b>	<b>28 x 1.60</b>	<b>700 x 40C</b>		
44-622	28 x 1.625	700 x 42C		
<b>47-622</b>	<b>28 x 1.75</b>	<b>700 x 45C</b>		
<b>50-622</b>	<b>28 x 2.00</b>			
		29 x 2.00		
		28 x 1.90		
	<b>55-622</b>	<b>28 x 2.15</b>		
		29 x 2.15		
	<b>60-622</b>	<b>28 x 2.35</b>		
		29 x 2.35		
	32-635	28 x 1 1/2 x 1 1/8	770 x 28B	
			700 x 28B	
			700B Course	
	<b>40-635</b>	<b>28 x 1 1/2</b>	<b>700 x 38B</b>	
		28 x 1 1/2 x 1 3/8	700B Standard	
	44-635	28 x 1 3/8 x 1 1/2	700 x 42B	
	28-642	28 x 1 3/8 x 1 1/2	700 x 28A	
37-642	28 x 1 3/8	700 x 35A		
<b>29"</b>	<b>50-622</b>	<b>29 x 2.00</b>		
		<b>28 x 2.00</b>		
	<b>54-622</b>	<b>29 x 2.10</b>		
		28 x 2.10		
	<b>55-622</b>	<b>29 x 2.15</b>		
		28 x 2.15		
	<b>57-622</b>	<b>29 x 2.25</b>		
	<b>60-622</b>	<b>29 x 2.35</b>		
		28 x 2.35		
	75-622	29 x 3.00		

28 inch and 29 inch tires have the same inner diameter of 622 mm and can be fitted on the same rims.

## What is actually the difference between 28 and 29 inches?

The silliest answer to this question would be to say that the difference is exactly 1 inch. Another answer would be: There is no difference.

Both tire sizes have the same inner diameter of 622 mm and can therefore be fitted on the same rims.

In Europe, 28 inches is a traditional size for touring bicycles. In many countries it is even the most frequent tire size used. In countries outside Europe the rim diameter of 622 mm is only rarely used. Bicycle travelers who want to buy spare tires for a 28-inch touring bicycle anywhere in the world, can tell you a thing or two about it.

A few years ago 29 inch tires were introduced as a new wheel size for mountain bikes in the US. The marking was created, as the MTB tires are more voluminous and the outer diameter measures approximately 29 inches.

Both indications are, however, very imprecise. A less wide 28 inch tire, e.g. with a tire width of 23 mm, which is usual for a road bike, has in fact only an outer diameter of something more like 26 inches. In the case of a tire width of 40 mm, it is more or less correct that the outer diameter measures 28 inches. In the case of very wide tires with 60 mm or more, the actual outer diameter measures almost 30 inches.



28" Touring bicycle



29" Mountainbike

## What are the advantages of the new wheel sizes 27.5 and 29 inches?

The new sizes are well established on the market and this is for good reason. The advantages of the large wheels outweigh the disadvantages. 29 inch wheels weigh a little more, are less maneuverable and possibly less stiff, but they roll clearly faster on rough surfaces especially in the terrain. The contact surface is bigger which makes for a significantly better tire grip.

There are, however, some bicycles which do not have enough clearance for a large 29 inch wheel, e.g. in the case of very small frame sizes and in particular bicycles with very long suspension travel. This is where the new wheel size 27.5 comes in.

Schwalbe will continue to offer all usual MTB tires for all three diameters.





## Why are tires often narrower than the stated tire size?

In order to ensure that tires have sufficient frame clearance, tire manufacturers generally prefer to keep production closer to the lower end of the permitted tolerance (+/- 3 mm).

Carcass casing materials have become more and more sophisticated over time. That reduces the tire widening after the fitting.

Furthermore, inflation pressure also plays a major role. With maximum inflation pressure the tire becomes wider than with low pressure. And a recently fitted tire still widens over time. This can make a difference of 1 to 2 mm.

The tire width is measured at the widest point, i.e. outside the lug.



## Will the tire fit into my frame?

The question whether tires will fit into a particular frame is often asked in relation to our ultra-wide tires.

Please bear in mind that with the large number of different bicycle models it is impossible to check the compatibility of all frames and tires.

The following list shows the exact diameters and widths of our ultra wide tires. This should allow you to identify if there is sufficient frame clearance for the selected tire.

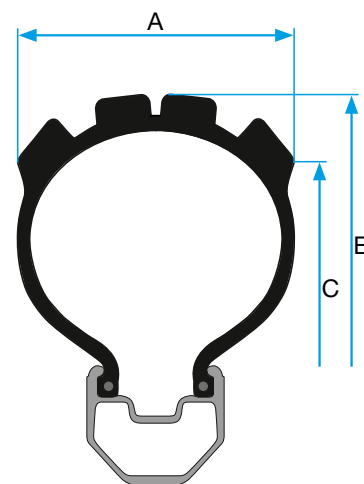

Inches	Size	Tire	Maximum width	Maximum diameter	Bead seat diameter with maximum width
24"	60-507	Crazy Bob	61	631	570
26"	60-559	Big Apple	58	683	625
		Big Ben	60	689	628
		Crazy Bob	64	685	629
		Dirty Dan	65	694	623
		Fat Frank	61	687	630
		Hans Dampf	60	684	621
		Ice Spiker/Ice Spiker Pro	60	686	615
		Magic Mary	60	687	621
		Nobby Nic	60	686	624
		Rock Razor	60	683	620
		Rocket Ron	60	687	628
		Space	63	693	621
	Super Moto	58	684	624	
	64-559	Magic Mary	67	701	636
27,5"	60-584	Dirty Dan	66	714	649
		Hans Dampf	63	710	645
		Magic Mary	62	713	641
		Nobby Nic	62	712	648
		Rock Razor	61	708	637
28"	50-622	Big Apple	48	722	670
		Big Apple Plus	51	729	677
	55-622	Big Apple	55	741	688
		Big Ben	57	744	688
		Marathon Almotion	55	744	687
29"	60-622	Big Apple	59	750	691
		Hans Dampf	62	749	684
		Magic Mary	61	751	678
		Nobby Nic	59	751	687
		Racing Ralph	59	747	686
		Super Moto	59	750	691

## Which tire fits which rim?

The inner diameter of the tire must match the rim bead seat diameter. For instance, a tire size 37-622 fits on a 622 x 19C rim.

Furthermore, the tire width must match the rim width. The following table shows possible combinations of tire widths and rim widths according to ETRTO.

There are many additional combinations which are not listed in this table, but nevertheless, work out in practice very well. It goes without saying that you ride with these combinations at your own risk. Unfortunately, the ETRTO standard in reality often lags behind. For example, very wide rims become more and more popular these days. The usage of wider rims also makes sense, because they support the tire's stability. You can reduce the inflation pressure, before the riding behavior becomes spongy.

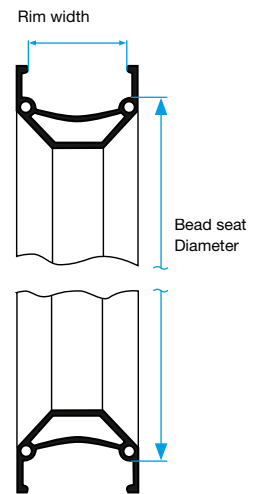

Tire width in mm	Rim width in mm (crotchet type rim)								
	13C	15C	17C	19C	21C	23C	25C	27C	29C
18	X								
20	X								
23	X	X							
25	X	X	X						
28		X	X	X					
32		X	X	X					
35			X	X	X				
37			X	X	X	X			
40			X	X	X	X			
42			X	X	X	X	X		
44			X	X	X	X	X		
47			X	X	X	X	X	X	
50			X	X	X	X	X	X	
52			X	X	X	X	X	X	X
54				X	X	X	X	X	X
57				X	X	X	X	X	X
60				X	X	X	X	X	X
62				X	X	X	X	X	X

Possible combinations of tire width and rim width (crotchet type rim) according to the ETRTO

## What is the exact circumference of my tire?

In order to accurately program a bicycle computer, it is generally necessary to enter the exact tire circumference.

The tire circumference varies depending on the rim, the inflation pressure and the load on the tire. For these reasons, it is not possible to list an exact tire circumference. In order to accurately program a bicycle computer, we recommend a simple rolling test with the rider on the bicycle.

Inches	ETRTO	approximate tire circumferences	Inches	ETRTO	approximate tire circumferences	Inches	ETRTO	approximate tire circumferences
16"	50-305	1265 mm	24"	57-507	1955 mm	28"	23-622	2125 mm
	35-349	1315 mm		60-507	1980 mm		25-622	2135 mm
	37-349	1330 mm		35-559	1990 mm		28-622	2150 mm
18"	40-355	1380 mm	26"	40-559	2030 mm	30-622	2160 mm	
	50-355	1440 mm		47-559	2050 mm		32-622	2170 mm
20"	23-406	1420 mm	27"	50-559	2075 mm	35-622	2185 mm	
	28-406	1450 mm		54-559	2100 mm		37-622	2200 mm
	35-406	1510 mm		57-559	2120 mm		40-622	2220 mm
	40-406	1540 mm		60-559	2160 mm		42-622	2230 mm
	47-406	1580 mm		37-590	2100 mm		47-622	2250 mm
	50-406	1600 mm		32-630	2200 mm		50-622	2280 mm
	54-406	1620 mm		54-584	2195 mm		40-635	2250 mm
24"	47-507	1900 mm	27,5"	57-584	2215 mm	29"	54-622	2310 mm
	50-507	1910 mm		60-584	2240 mm		57-622	2330 mm
	54-507	1930 mm		20-622	2100 mm		60-622	2340 mm

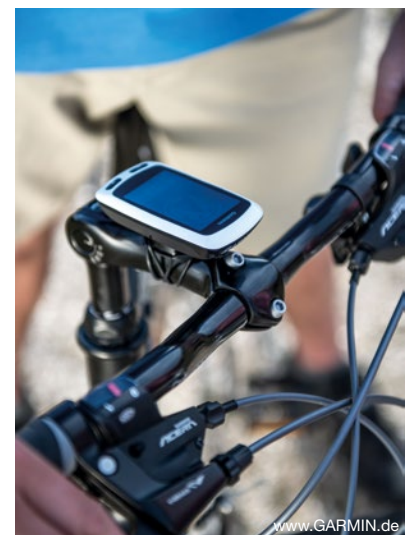

The approximate tire circumferences for the most common sizes are listed in the table below.

## What components make up a tire?

A bicycle tire consists of three basic elements: the carcass, the bead core and the rubber tread. Furthermore, almost all Schwalbe tires have a puncture protection belt.

The **bead core** of the tire determines its diameter and ensures a secure seat on the rim. Generally the bead core of a tire consists of a wire bundle. In folding tires, the wire is replaced with a hoop of aramid fibers.

The **carcass** is the “framework” of the tire. The textile material is rubber coated on both sides and cut at a 45 degree angle. With this angle placed in the rolling direction, the carcass provides the tire’s necessary stability. All Schwalbe carcasses are made of polyamide (nylon). Depending on the quality requirements of the tire, the carcass materials are woven in various densities.

The **rubber compound** of a tire consists of several components:

- Natural and synthetic rubber
- Fillers, e.g. carbon black, chalk, silica
- Softeners, e.g. oils and lubricants
- Anti-aging agents (aromatic amines)
- Vulcanizing aids, e.g. sulphur
- Vulcanization accelerators; e.g. zinc oxide
- Pigments and dyes

Depending on the compound, the rubber content is around 40-60%. The filler amounts to 15-30% and the remaining components approx. 20-35%.

Almost all Schwalbe tires have a puncture protection belt, with the exception of special lightweight and sports tires, where this feature is purposely excluded. Even our standard tires are equipped with an effective puncture protection belt made of natural rubber and reinforced with Kevlar® fibers (K-Guard). In the case of the Marathon tires the 3 mm thick GreenGuard ensures the renowned high puncture protection. Furthermore, our top of the range tires have highly efficient puncture protection systems, which are specifically adapted to particular requirements, for example RaceGuard, V-Guard or SmartGuard.

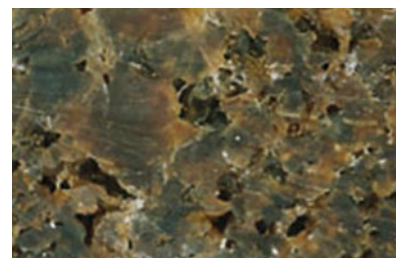
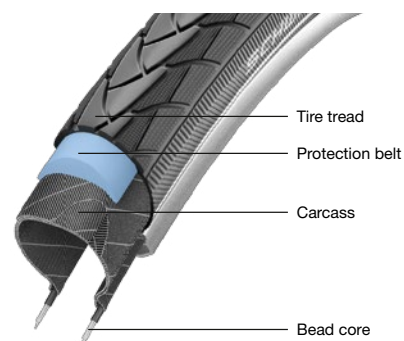

Natural rubber

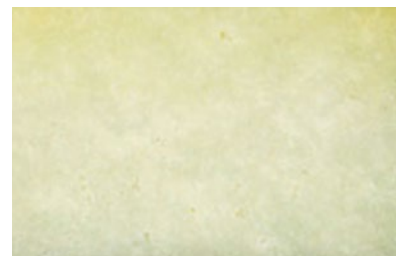

Synthetic rubber

## How is a bicycle tire manufactured?

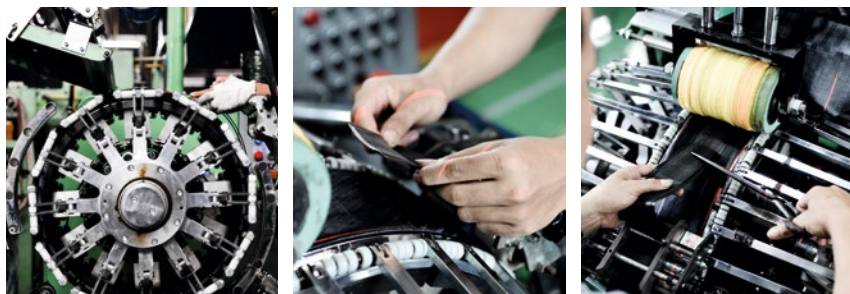

The tire is manufactured from the prepared materials in a unique process. This is highly labor intensive and of course facilitated by using the latest modern machinery.

The carcass is applied to the building drum, cut and then spliced. As a next step, the wire or aramid bundles are inserted and the carcass is folded from both sides. The 45 degree-angle carcass material is now layered and forms a tire with a diagonal structure.

In this phase, the respective puncture protection layer is inserted. Finally, the tread is applied exactly in the center of the tire.

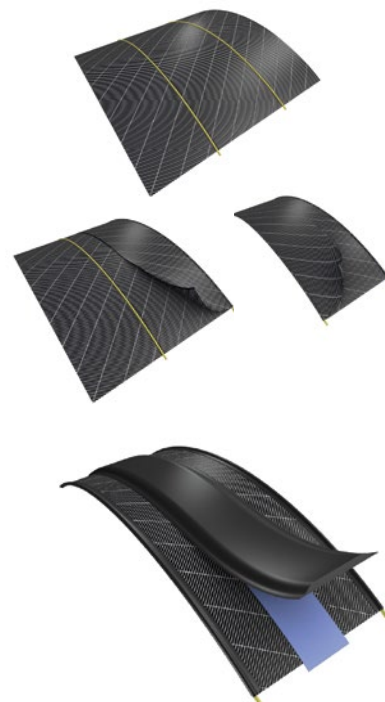

But the green tire is still in a pliable form without a tread. Only during the vulcanization process in the mold, does the tire get its tread and its elastic properties.



The green tire is pressed into a tire mold by a special heating tube and – like in a waffle iron - vulcanized at approx. 170 degrees for five to six minutes.

Only after vulcanization can it be called rubber. Now the tire has its elastic properties and its tread.

After the production process every tire undergoes a strict quality control. Every tire is meticulously inspected once again. Continuous checking of random samples ensures correct weight and run-out.



## Where are Schwalbe tires manufactured?

All Schwalbe tires are manufactured in Indonesia. Our state-of-the-art Schwalbe plant has more than 3000 employees who produce far more than one million bicycle tires per month.

The plant has existed for more than 20 years now. It is a joint venture between the German company Ralf Bohle GmbH and the Korean family company Hung-A.

All Schwalbe tires and all Schwalbe tubes are manufactured in the Schwalbe-owned plant. This exclusivity applies unreservedly. Schwalbe does not buy from other production facilities and no tires are produced for other brands.



## What is the reason for Schwalbe manufacturing their tires in Indonesia?

This is due to **the history of the company**. Schwalbe tires have never been manufactured in Germany. In former days, the Bohle company was a very small trading house dealing with all kinds of bicycle components. The Schwalbe story starts in 1973, when Ralf Bohle imported bicycle tires from Korea to Germany for the first time. This was such an interesting business for him that he concentrated on that from this moment on. Back then as well as today the business is operated in close partnership with the Korean partner company Hung-A.

Of course, the location also has to do with **labor costs**. The production of bicycle tires is mainly manual work. For this reason the production was shifted from Korea to Indonesia in the 90's.

There are resources of natural rubber, the most important **raw material** for the production of tires, in Southeast Asia which would have to be imported for the production of tires in Europe.

For a country like Indonesia production facilities like the Schwalbe plant provide considerable **opportunities for development**. By building up own industries and processing regionally available raw materials, Indonesia was able to increase the overall standard of living significantly over the last years.

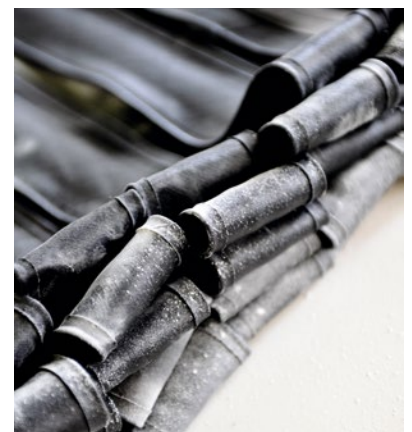

## What are the working conditions in the Schwalbe production facilities?

Of course, the working conditions in Indonesia are not comparable to those, for example, in highly industrialized Germany. We believe, however, that our employees have a good job.

They work in three shifts. One shift lasts eight hours; in Indonesia the working week is usually six days. The wage level is far above the national average.

We are highly dedicated in retaining our employees in Indonesia by maintaining a good working environment. One example for that are the experience and the personal skills of the workers at the finishing machines, which have a major impact on the quality of the finished tires. And the reliable, consistently state-of-the-art quality is one of the essential properties of tires from Schwalbe.

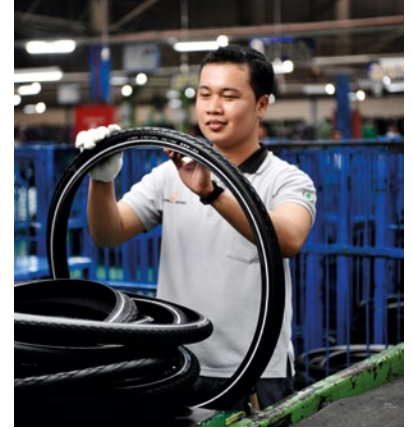

## What does EPI mean in relation to the carcass?

The density of the carcass fabric is expressed in EPI or TPI (Ends Per Inch, Threads Per Inch). The range of carcasses used, for example, for bicycle tires are 20, 24, 37, 50, 67 and 127 EPI.

In principle, the more close-meshed a carcass is woven, the higher the quality of the tire. A dense carcass is important for low rolling resistance and good riding properties. At the same time, puncture protection increases, because carcasses with a high strand density are difficult to puncture.

However, this does not apply to the extremely fine 127 EPI carcasses, as each strand is sheer and quite vulnerable. The best compromise for low weight and resistance is around 67 EPI.

In most of our top tires we use a 67 EPI carcass. Weight and rolling resistance can be reduced even further by using a 127 EPI carcass. But at the same time, these tires are more vulnerable to damage. Therefore, we intentionally use the 127 EPI carcasses only for light competition tires, where weight is an important factor.

Most bicycle tires worldwide are certainly manufactured with coarse 20 or 24 EPI materials. This material has no longer been used at all by Schwalbe for a couple of years now. Even very low-priced Schwalbe tires already have a state-of-the-art 50 EPI carcass.

But be cautious when comparing EPI indications, as often the number of strands of all carcass layers are added together. An indication of 200 TPI results e.g. from 3 layers of 67 EPI each underneath the tread. With all EPI numbers above 150, it should be assumed that the figures have been calculated by adding up the strands in all layers. Schwalbe only indicates the material density in one carcass layer. Commonly, there are 3 carcass layers underneath the tread.

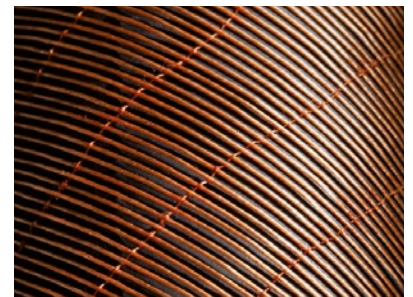

Coarse carcass

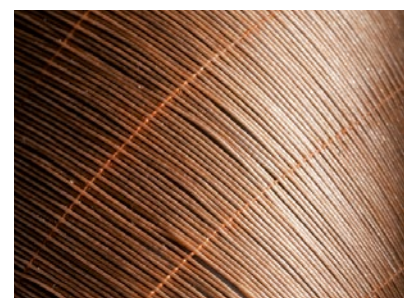

Dense carcass

- 20/24 EPI = low-price tires
- 50 EPI = Schwalbe minimum standard
- 67 EPI = good performance tires
- 127 EPI = super light competition tires

## Does a perfect rubber compound exist?

A rubber compound should have various properties that are to some extent contradictory: Low rolling resistance, good adhesion, low abrasion, long durability, solid lugs (MTB), etc.

The conflicting targets of low rolling resistance and good wet adhesion always attract particular attention. Good adhesion implies that the tire must “absorb” a lot of energy while low rolling resistance requires a rubber compound with low energy “consumption”. A good compromise is achieved with SILICA filler for example.

We prepare universal compounds which comprise all relevant properties as far as possible, as well as special compounds with extreme characteristics. The universal compounds are used, for example, for the ENDURANCE rubber compound in the case of the Marathon tire or the SPEEDGRIP compound in the case of the sport tires. A very effective possibility to optimize all relevant properties in one tire is the Triple Compound Technology. Special rubber compounds are used in various areas of the tread – substructure, bead seat, center – which exploit their respective strengths.

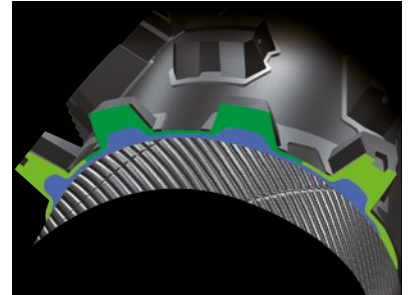

MTB tire with Triple Compound

## Why are reflective lines used?

Reflective lines are clearly visible when illuminated by a car headlight. The material is retroreflective, i.e. it reflects in the direction of the radiation source. The two tire-sized circles of light make a cyclist easily seen and recognized.

German Motor Vehicle Safety Standards (StVZO section 67 (7) allow this as an adequate replacement for wheel reflectors. In the Netherlands the reflective lines are even compulsory. Other reflectors are only permitted when they form a similar circle of light like the reflecting rings on the tire.

The European mark of conformity certifies conformity with all legal requirements for lighting equipment (ECE – Regulations 88). That means for the reflective lines, light reflection is sufficiently strong and bright, even at an unfavorable angle.

Because of this considerable safety advantage, we began to use reflective lines years ago as standard for all high-quality touring and city tires.



ECE 88R mark of conformity

## What is a clincher tire?

Today clincher tires are standard for bicycles. See Tire Construction. The wire bundle in the tire bead prevents the tire from expanding with the pressure and thus from jumping off the rim. **Clincher** is the international designation for this type of tire.



Wire core



Kevlar bead

## What is a folding tire?

A folding tire is a special version of the clincher tire. The wire bundle is replaced by a bundle of Kevlar strands. This enables the tire to be folded up and depending on the tire size, makes it approx. 50-90 g lighter.

Marathon Mondial  
as a folding tire

## What is a tubular?

In a tubular tire, also referred to as Tubular or Collé, the tube is sewn directly into the tire. The tire is then glued onto a special rim.

Many professional road racers still swear by them, claiming that they provide a better “feeling” and that the tires have more “life”, i.e. better comfort and smoother cornering. At least with regard to rolling resistance, this assumption is now outdated. Modern folding tires have certainly caught up with tubular tires in terms of rolling resistance and roll even easier.

However, a clear advantage of tubular tires lies in their run-flat capability. Even with a flat, the tire stays on the rim. The rider can safely stop without losing control of the bicycle, or even slowly ride on until the team car arrives.

Tubular tires are an option to reduce weight on a wheel. As a tubular tire rim does not need pressure retaining sidewalls, it is easier to construct. The tubular tire itself weighs approximately the same as a folding tire and its tube.

The drawback of tubular tires is its fitting. Sticking the tire onto the rim with glue is much more awkward than fitting a clincher tire. Furthermore, the tubular tire cannot be repaired easily like a tube. Smaller defects can be repaired with a puncture protection liquid. Otherwise, the entire tubular tire must be changed. Also, the manufacturing process is more labor intensive. That is why top quality tubular tires are so expensive.

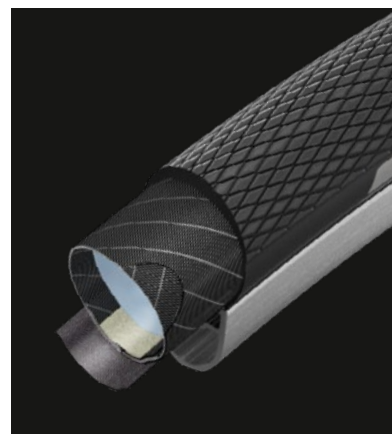



## What is a tubeless tire?

As the name implies the tubeless system needs no tube. The tire and the rim are made in such a way that fitting them together provides an airtight seal. Special tires and rims are necessary.

We at Schwalbe are convinced however: Tubeless is the tire technology of the future. When it comes down to best performance on the bike, the tubeless technology brings clear advantages, no matter whether MTB, road bike or touring bike. For all ambitious cyclists tubeless is the right choice.

Tubeless tires provide clear advantages in speed, comfort, grip and puncture protection. They avoid unnecessary friction between tires and tubes, which reduces the **rolling resistance** even more than with super light competition tires. Tubeless tires can be used with a lower inflation pressure without compromising performance. That brings clear advantages in **comfort** as well as clearly more control in critical situations and on trails with poor surfaces. At the same time, tubeless systems provide a high **puncture protection**. The danger of blowouts is clearly reduced. A sudden loss of air pressure caused by a burst tube or a valve tear off is excluded. What is more, tubeless systems function perfectly together with puncture protection liquids. Punctures are re-sealed within milliseconds.



"Normal tire"

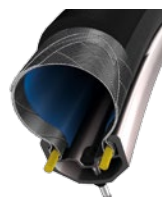

Tubeless tire

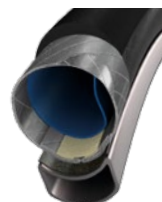

Tubular tire

## What does Tubeless Ready or Tubeless Easy mean?

Tubeless Ready tires are not tubeless tires. By using sealing liquid in a special process they can, however, be converted into tubeless tires. Schwalbe Tubeless Ready tires have a coated tire bead which has a special shape. This provides a good sealing with the rim and a perfect fit.

Tubeless Easy is the name of the latest variant of Tubeless Ready tires. A new monofilament texture on the sidewalls (SnakeSkin) ensures an extremely light tubeless conversion. The usage of sealing liquid is necessary, but the fitting is as easy as with genuine tubeless tires. There are no long conversion processes with intensive shaking and repeated inflating.

Tubeless Easy is the standard for state-of-the-art MTB tires from Schwalbe (Evolution Line). Tubeless Easy has replaced the existing tubeless tires as well as the Tubeless Ready design.



## What is the difference compared to normal tires?

The conversion from normal tires into tubeless tires is something road racers have been practicing for quite a long time. With the Schwalbe Tubeless Ready and Tubeless Easy tires this conversion is significantly easier. The special tire bead provides an immediate sealing with the rim and a perfect fit. In the case of normal tires the sealing in the area of the rim is very problematic, as it often works only by using a compressor and takes a lot of patience. Often, it takes several days until this transition area is actually sealed. There is also an increased risk of the tire coming off, as the tire cores are not designed for being used as tubeless tires.

Due to the necessary high inflation pressure for a road bike, it is absolutely impossible to convert classic tires to tubeless tires. A normal tire bead will not withstand these forces and the tire will almost certainly come off. **Be sure to only use tires which are designed for tubeless fitting!**

## What does the tire tread do?

On a normal, smooth road, the tread has only limited influence on the riding properties. The grip generated by the tire on the road is almost exclusively the result of the rubber compound.

Unlike a car, a bicycle will not **aquaplane**. The contact area is much smaller and the contact pressure is much higher. The floating effect of aquaplaning could only theoretically be achieved on a bicycle ridden at speeds over 200 km/h.

Off road though, the tread is very important. In this situation the tread establishes an interlocking cog-like connection with the ground and enables the transmission of all driving, braking and steering forces. On rough or dirty roads, the tread can also contribute to better control.



Smart Sam, treaded MTB tire

## Why ride a slick tire?

On a normal, smooth road, even in wet conditions, a slick tire actually provides better grip than a tire with a tread, because the contact area is larger.

The situation is much different on a rough road and even worse on a dirt trail. In these cases the degree of control provided by a slick tire is extremely limited.

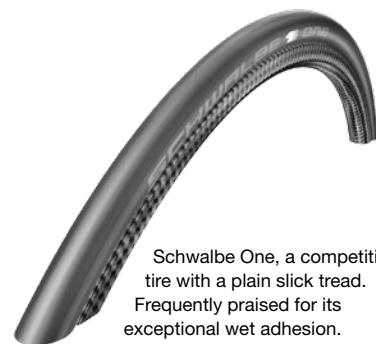

Schwalbe One, a competition tire with a plain slick tread. Frequently praised for its exceptional wet adhesion.

## What do the direction arrows mean?

Most Schwalbe tire sidewalls are marked with a **“ROTATION”** arrow, which indicates the recommended rolling direction. When in use, the tire should run in the direction of the arrow. Older tires have the marking **“DRIVE”**, but it has the same meaning.

Many MTB tires are marked with a **“FRONT”** and a **“REAR”** arrow. The **“FRONT”** arrow indicates the recommended rolling direction for the front wheel and respectively the **“REAR”** arrow is the direction for the rear wheel.



## Why are so many treads direction dependant?

In the case of a road tire the rolling direction is mainly important for aesthetic considerations. Tires marked with arrows simply look more dynamic.

Off road, the rolling direction is far more important, as the tread ensures optimum connection between the tire and the ground. The rear wheel transmits the driving force and the front wheel transmits the braking and steering forces. Driving and braking forces operate in different directions. That is why certain tires are fitted in opposite rotating directions when used as front and rear tires.

There are also treads without a specified rotating direction.



Marathon Racer, rolling direction road tread

## What exactly is rolling resistance?

Rolling resistance is the energy that is lost when the tire is rolling. The main reason for the loss of energy is the constant deformation of the tire.

Each bicycle tire should, of course, roll as easily as possible. In contrast to a car a cyclist has only (very limited) physical power which he wants to apply as efficiently as possible.

In addition to the rolling resistance, there are also other resistances that must be overcome when riding a bicycle:

The **air resistance** rises in a squared ratio with increased speed. At a speed of approx. 20 km/h on level ground, air resistance has already become the main resistance force.

**Acceleration** energy is also expended. For instance, the weight of the wheels is of great importance when this mass has to be brought up to rotation.

When riding uphill, the main resistance force to be overcome is the **gradient resistance** (grade resistance).

In addition to these, there are other friction resistances in the chain and in other rotating parts. Yet in a well-serviced bicycle, these represent a very minor part of the total resistance.

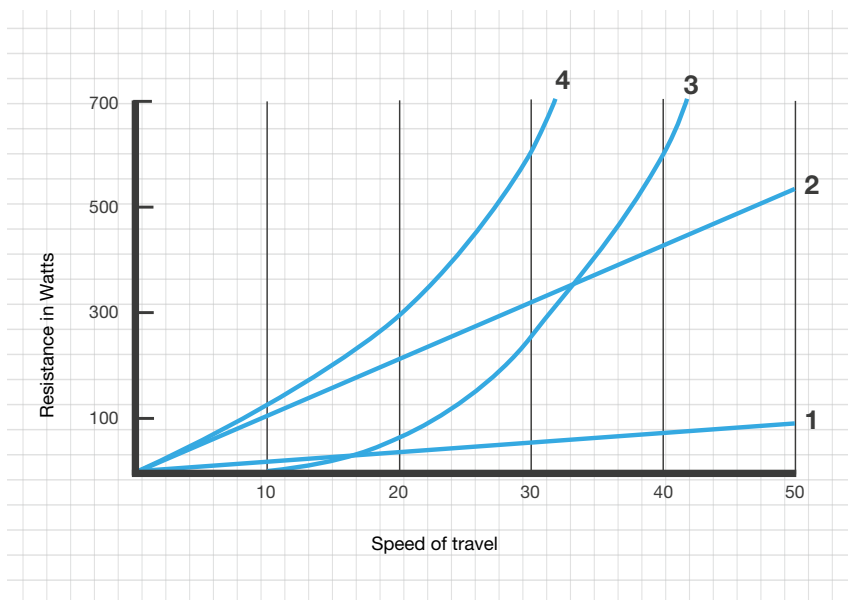

Resistance force on a bicycle  
 1 Rolling resistance  
 2 Gradient resistance (gradient 5%)  
 3 Air resistance  
 4 Total resistance

## Which factors affect rolling resistance?

Tire pressure, tire diameter, tire width, tire construction, tire tread and other factors all have an effect on rolling resistance.

On a completely smooth surface the following applies: The higher the **inflation pressure**, the inferior the tire deformation and thus rolling resistance.

Off road it is exactly the reverse: The lower the inflation pressure, the lower the rolling resistance. This applies equally on hard gravel roads and soft forest tracks. Explanation: A tire with low inflation pressure can adapt better to a rugged surface. It sinks into the ground less and the whole rotational mass is held back much less by the uneven surface.

Tires with a **smaller diameter** have a higher rolling resistance with the same inflation pressure, because tire deformation is proportionally greater. The tire is flattened more and is "less round".

**Wider** tires roll better than narrower tires. This statement generally invokes skepticism, nevertheless, with tires at the same pressure a narrower tire deflects more and so deforms more.

Obviously, tire **construction** also has an effect on rolling resistance. By using less material, less material can be deformed. And the more flexible the material is, such as the rubber compound, the less energy is lost through deformation.

Generally, smooth treads roll better than coarse **treads**. Tall lugs and wide gaps usually have a detrimental effect on rolling resistance.

## Why do wide tires roll better than narrower tires?

The answer to this question lies in tire deflection. Each tire is flattened a little under load. This creates a flat contact area.

At the same inflation pressure, a wide and a narrow tire have the same contact area. A wide tire is flattened over its width whereas a narrow tire has a slimmer but longer contact area.

The flattened area can be considered detrimental to tire rotation. Because of the longer flattened area of the narrow tire, the wheel loses more of its “roundness” and produces more deformation during the rotation. In a wide tire, the flattened area is shorter in length and does not have so much effect on the rolling direction. The tire stays “rounder” and therefore it rolls better.

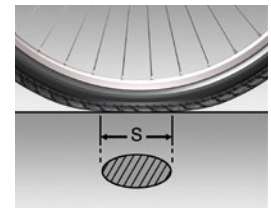

Wide tires

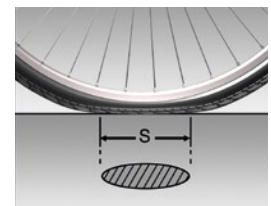

Narrow tires

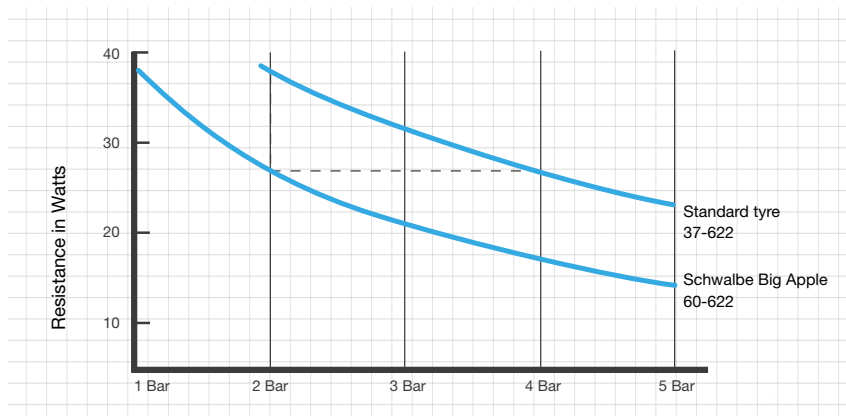

Rolling resistance:  
At 2 bar already a 60 mm wide tire rolls as well as a 37 mm tire at 4 bar.

## Why do professional road racers use narrow tires?

Wide tires only roll easier with the same inflation pressure. Narrow tires are used however with a higher inflation pressure, which makes them of course less comfortable.

In addition to this, narrow tires have an advantage over wider tires at higher speeds, as they provide less air resistance.

Above all, a bicycle with narrow tires is much easier to accelerate, because the rotating mass of the wheels is lower and the bicycle is much more agile. The importance of this aspect becomes clear very quickly, when you ride in a fast group of cyclists and when you have to accelerate rapidly from 20 to 40 km/h after a sharp turn in order to keep up with the others.

But at a constant speed of around 20 km/h, the ride is better with wider tires. In practice, the energy saving is even greater than in theory, as the elasticity of the tires absorbs road shocks, which would otherwise be transferred to the rider and thus saves energy.

And professional road racers are tending to ride wider tires more and more. The tire widths of 18 and 20 mm are hardly available anymore. And instead of the current standard width of 23 mm, the professional road racers choose more and more tires with widths of 24 or 25 mm.



© Watson

## How can a puncture be prevented?

The best and most important protection against punctures is a high-quality tire with a good **puncture protection belt**.

Maintain the correct **inflation pressure**. If the inflation pressure is too low, the risk of punctures is substantially higher. Check and correct the inflation pressure at least once a month with a pressure gauge.

**Tire control:** It also helps to check the tire for embedded foreign objects and to remove them. Replace worn tires.

The best protection belt will not serve any purpose if “internal safety” is not observed. Only purchase quality tubes. The **rim tape** is also important. The rim tape protects the tube from mechanical damage from spoke ends, metal burrs and holes in the rim. An appropriate rim tape must completely and securely cover all spoke holes.

**Puncture protection tapes** can be inserted between the tire and tube at fitting. They protect from punctures, but are not without problems because they lie between the tire and the tube and cause defects due to friction. Therefore, we do not offer protection tapes separately. It is better that the protection belt is incorporated into the tire.

In certain cases the use of a **puncture protection liquid** is helpful.

**Latex tubes** are favored as a puncture protection means as well. The chapter “Tube” explains the advantages and disadvantages.



Tried and tested for more than 30 years.  
The Marathon with puncture protection belt



Schwalbe High Pressure Rim Tape

## Which is the best puncture protection belt?

The safest bicycle tire for most purposes is our “**flat-less**” tire Marathon Plus. The **SmartGuard** belt, made out of highly elastic special rubber, is approx. 5 mm thick. The decisive advantage of SmartGuard is its effectiveness against objects that become lodged in the tread, that are rolled over at each turn of the wheel and will eventually penetrate virtually any protection belt. This is where the advantage of SmartGuard comes into effect. A thumbtack, for example, is embedded in the rubber without causing any damage.

This simple operating principle is superior even to high-tech protection belts made of aramid or Vectran. However, these belts have another advantage. They provide very light tires with a very good puncture protection. The fibers themselves are highly cut-resistant. These fibers are woven using patented weaving technology to produce a very tightly woven texture for our **V-Guard**.

Both technologies are patented.



A puncture can never be completely avoided.  
You are very well protected against the typical puncture demons like shards and granular material with the Marathon Plus.

## How should puncture protection liquids be used?

Basically, there are two kinds of puncture protection liquids. The first kind works solely mechanically. The liquid contains small fibers or particles that will close the hole. Advantage: Such liquids can stay in the tube for an unlimited amount of time. Disadvantage: The hole is not really repaired but only plugged and it can open up again e.g. the next time the tire is inflated. The second kind of liquid is latex based. The latex milk hardens in the puncture and provides a lasting repair. Unfortunately, these kinds of liquids can only stay in the tube for a limited amount of time before they cure completely.

Our **Doc Blue** is also based on latex and is effective in the tube for approx. 2-7 months or approx. 2000 km as a preventative. Additional particles in the liquid ensure that larger holes are also quickly sealed. These particles in the liquid are also the reason that the valve core must be removed for filling. Liquids, which can be filled with the valve installed, are usually extremely thin and therefore only able to seal very small holes.

For all puncture protection liquids, the following applies: The liquid can only seal the hole when the wheel rotates. Handling can be problematic. A good, puncture protected tire is the best and simplest solution for most people.

We recommend Doc Blue **mainly for tubeless systems** and **tubular tires**. In these cases it is a useful aid as otherwise these tire types either cannot be repaired at all or only with great difficulty. Furthermore, Doc Blue is suitable for preventing punctures in particularly light tires for a limited time, for example, a competition. It also makes sense as an additional protection for touring in extremely thorny areas.

In an emergency Doc Blue can repair small punctures without dismantling tube and tire. However, greater damage, like cuts or snakebites, cannot be repaired with a latex solution.



Doc Blue - the liquid patch



## When is a tire worn out?

In bicycle tires the tread is far less important than for instance in car tires. So using a tire with a worn out tread is less of a problem that is of course with the exception of MTB tires.

When the puncture protection belt or the carcass threads can be seen through the tread the tire has reached its wear limit and must be replaced. As puncture resistance also depends on the thickness of the tread layer, it may be useful to replace the tire sooner.

The sidewalls of tires often fail before the tread is worn out. In most cases, this premature wear is due to prolonged use of the tire with insufficient pressure. Checking and re-pumping the inflation pressure at least once a month with a pressure gauge is most important.



Tread is worn out. Rubber is still present.  
This tire could still be ridden.



The puncture protection layer can be seen.  
The tire must be changed urgently.

## What mileage can be achieved with various tires?

It is difficult to answer this question, as mileage is influenced greatly by tire pressure, load, road surface, temperature and the rider. For example, when used in hot weather with a heavy load and on rough asphalt, a tire wears much faster.

As a general guide, you can expect a tire mileage of 2000 to 5000 km from Schwalbe standard tires.

The tires of the Marathon family usually last between 6000 and 12000 km. With the light Marathon Racer and Marathon Supreme, the performance is a little lower (approx. 5000 to 9000 km). The Marathon Plus is outstanding with its extremely high mileage of often much more than 10000 km.

No useful mileage data is possible for MTB tires, because the influence of riding style is too dominant. Our racing bike tire Schwalbe One lasts from 3000 to 7000 km.



Marathon Plus. The bicycle tire  
with the highest mileage

## Why do many tires wear prematurely?

Unfortunately, many tires do not reach the possible mileage because they are continually ridden at inflation pressures that are too low. Insufficient inflation pressure means the tire cannot bear heavy loads. The tire sides have to deform excessively when running. The tire can only stand this kind of treatment for a limited time. At a certain point there is too much load on the sidewall and it tears.

Fig. 1 shows the typical fatigue cracks which arise from low inflation pressure. A few large cracks in the upper area of the sidewall. In comparison the second figure shows normal aging cracks (due to old age and/or poor rubber compound). These cracks are rather small and distributed evenly across the whole sidewall. In practice the transition between these two crack types is often seamless so that the cause is not always clearly visible.

Figures 3 to 5 also show clear symptoms of continued riding with insufficient inflation pressure. Typical abrasion marks: The tire is not bald in the center but on the left and right sides. Typical walk traces in the tire and on the tube.



Fatigue cracks



Aging cracks



Abrasion marks



Walk traces



Walk traces

## Why do tires of multi-track vehicles often wear down so fast?

Our tires are usually designed for bicycles and therefore not always suitable for multi-track vehicles, such as tricycles.

Unlike a (single-track) bicycle, a tricycle usually will not tilt in a curve. In a curve the vehicle then “pushes” transverse to the direction of travel via the steered front wheels (understeering). Depending on the riding style and the vehicle design this effect can result in a significantly increased wear.

An extremely increased wear, e.g. when the tires are worn down after less than 1000 km already, can be the indication for an improperly adjusted tracking of the vehicle. Even when riding straight ahead the tires which are standing transverse to the direction of travel generate increased friction and thus excessive wear.

The same also applies to trailer tires. Usually, the tires of a bicycle trailer must neither transfer driving nor steering forces. That's why these tires show clearly less abrasion than bicycle tires. If these tires are affected by remarkably heavy wear, this has most probably to do with the tracking adjustment of the trailer.



## How long can a tire be stored?

Schwalbe tires can be stored for up to **5 years** without a problem. If possible, they should be stored in a cool, dry and, most importantly, a dark place. When stored properly, even longer storage times may be possible.

If fitted on a rim, tires should always be inflated or the bicycle should be hung up for storage. A bicycle left on flat tires for an extended period of time may damage the sidewalls of the tire.

## What is a bicycle tube made of?

A bicycle tube is predominantly made of Butyl rubber. Butyl is a very elastic and airtight synthetic rubber. But as with the tire, other fillers are necessary to make up the rubber compound. The quality of a tube can vary significantly depending on the rubber compound. For instance Schwalbe tubes have extremely high air retention and elasticity. This high elasticity allows a wide range of different tire sizes to be covered.

There is a difference between **heat molded** and **autoclave** tubes. Vulcanizing in a mold improves the uniformity of wall thickness, thus reducing weight and improving air retention. For this reason the autoclave tubes which can be produced easier have become less common over the past years. Schwalbe tubes have always been made using the heat molding process.

Every tube also needs a valve, which is bonded to the tube during the vulcanizing process.



## Which special features does a Schwalbe tube offer?

Besides the quality of the ingredients, the purity of the rubber compound is decisive for the quality of the tube. Before extrusion, the basic material is forced through a total of seven filters under enormous pressure. All tubes are inserted and inflated into a mold for the vulcanization process. Only this ensures an even wall thickness and high **air retention**.

All tubes are inflated and stored for 24 hours to test for air retention. Afterwards, every tube is carefully checked individually by visual inspection. The Schwalbe tube has been valued by German bicycle dealers for its high reliability for many years.

A tube covers many tire sizes through its high elasticity and quality. Tube no. 17 works with tires from a width of 28 mm up to 47 mm - a great advantage for stock-holding in the trade. At the same time, it is proof of the quality of the tube.

All valves are nickel-plated and threaded. The valve core is always replaceable. Also, Schwalbe tubes with a classic bicycle valve can be inspected for pressure as they have a high-pressure valve core.



## What are the advantages of latex tubes?

Tubes made out of latex are more elastic than normal butyl tubes. This makes them roll a little more easily. Their greatest advantage lies in the high level of **puncture protection**. The highly elastic latex material is very difficult to puncture.

The disadvantage lies in **poor air retention**. A tire with a latex tube must be adjusted for inflation pressure before every trip. This explains why latex tubes are not well suited for everyday use.

In addition, latex tubes are very delicate and susceptible to oil, daylight, heat and uneven expansion. The tube must also be replaced every time a tire is changed. Because these sensitivities lead to many problems in the field, we do not offer latex tubes.

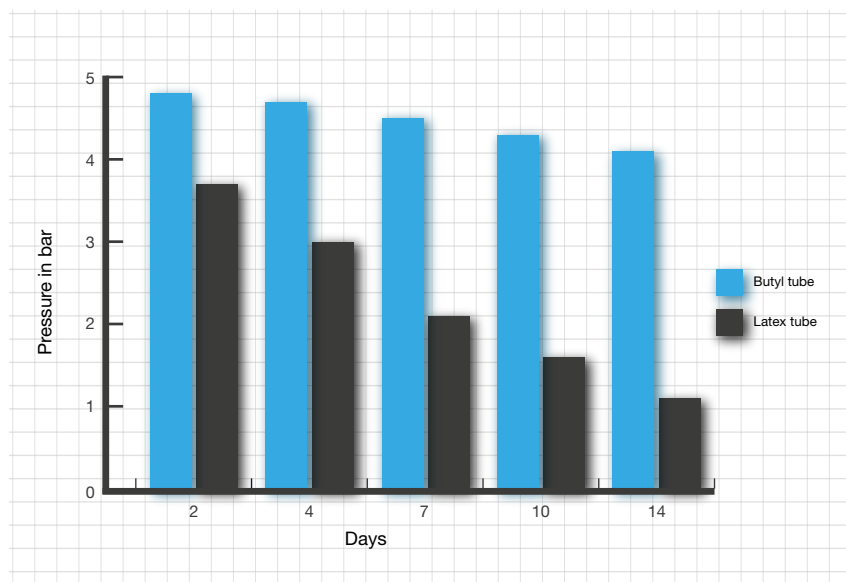

Comparison of air retention

## Which is the best valve?

There are three types that have become market standards and it is difficult to make any particular recommendation. The most important aspect is that the valve fits the rim valve hole and that an appropriate pump is available. Contrary to popular belief, major air retention differences are now a thing of the past. In any case, all Schwalbe valves provide excellent performance and are adapted to high-pressure use.

The **classical bicycle valve** or **Dunlop valve** is still the most common worldwide. Most cyclists are familiar with it. The valve core can easily be replaced and air can be released very quickly. Fitting a tube with a Dunlop valve is more awkward, as the valve core and locknut need to be removed in order to fit the valve through the valve hole. Inflation is only possible once the core and the nut are back in place.

With traditional Dunlop valves, it is impossible to check the inflation pressure. However, the special Schwalbe Dunlop valve allows a return airflow, so that it is now possible to check the inflation pressure with an Airmax pressure gauge.

Formerly it was difficult to inflate a tube with a Dunlop valve, but with today's modern valve cores, this is no longer the case.

The **Sclaverand valve** is narrower than other valves (6 instead of 8 mm). It needs a smaller rim hole and is therefore particularly well suited for narrow racing bike rims. It is also approx. 4-5 g lighter than a car valve or Dunlop valve.

It can be locked manually with the knurled nut. Before inflating, the knurled nut must be loosened. First time users frequently have some problems. Also the thin top pin can be easily bent when attaching and removing the pump connector.

Caution: Be aware that using Sclaverand valve tubes on rims with larger valve holes often leads to a valve tear off when the sharp metal edges around the valve hole cut the valve stem off the tube.

The **Auto/Car valve** can be inflated very easily at a filling station and is pleasantly unproblematic. Older, as well as simple bicycle pumps are not compatible with car valves.

The **Italian/Regina valve** looks very much like the French valve and is used almost exclusively in Italy.



Traditional bicycle valve  
Dunlop valve  
Easy pump valve "Blitzventil"



Sclaverand valve  
Presta valve  
French valve  
Racing bicycle valve



Auto/Car valve  
Schrader valve



Regina valve  
Italian valve

## What is the purpose of a rim nut?

The rim nut fixes the valve in the rim. Some regard it as unnecessary. And indeed, you may well ride your bicycle without a rim nut. It is however helpful when attaching the pump connector, as particularly when the pressure is low the valve may fall inside the rim. With some rims there may be a rattle if the valve is not fixed.

The rim nut must only be tightened by hand. Never tighten the rim nut with pliers, as this can lead to tube damage.



## What causes a valve tear off?

A valve tear off can occur if it was installed under tension.

Another frequent cause is installing a Schläverand valve tube into a rim with a larger **valve hole**. The metal edge of the valve hole can shear the valve stem off the tube.

Caution: Be aware that there are also rims that have the correct valve hole of 6.5 mm on the outside, but a larger hole of 8.5 mm on the inside, which causes the problem. A nut that is excessively tightened just exacerbates the problem of tear off. The major role of the rim nut is to lock the valve in place at the time of inflation.

In most cases valve tear off is due to **tire slip**. Continual improvement in brake performance and low inflation pressures often cause the tire to slip on the rim. The tire movement then drags the tube and this can lead to the valve shearing off.



Torn valve stem

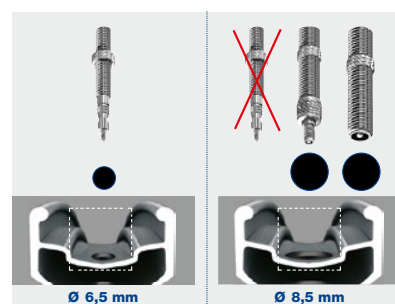

## What can be done to prevent tire slip or valve tear off?

A higher **inflation pressure** considerably reduces the tire slip. Of course a higher tire pressure is not always desired.

We implement Limited Slip Technology (**LST**) in Schwalbe MTB-folding and balloon tires. The tire bead is coated with a special rubber layer that produces a dramatic reduction in tire/rim slip.

The Schwalbe **Downhill tube** has a highly reinforced valve foot.

Theoretically, the use of talcum powder is also helpful. This can reduce the friction between tire and tube. However in practice, if **talcum powder** gets between tire and rim, it will increase the problem.

Some rims have such slippery surfaces that even LST does not suffice one hundred percent. It will help if the rim contact area with the tire is lightly **abraded** with **sandpaper** (180 grade). This considerably increases the friction between tire and rim.

The problem is very much reduced with **disc brakes** because the rims do not get hot through braking.

There is no valve tear off with **tubeless tires**. The tire can move without causing problems.

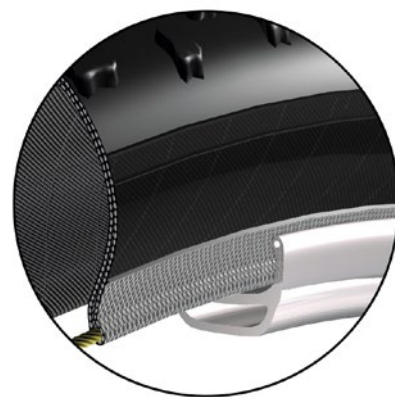

Schwalbe tire with L.S.T. coating on the bead

## How is a bicycle tire fitted?

- An appropriate rim tape must completely and securely cover all spoke holes (fig. 1).
- Observe any rotation direction markings on the tire sidewall. Fit one side of the tire onto the rim.
- Slightly inflate the tube until it is round. Fit the valve through the valve hole in the rim.
- Place the tube into the tire (fig. 2).
- Never use sharp fitting tools (fig. 3).
- Starting opposite the valve, mount the other tire side onto the rim. Ensure the tube is not pinched between the rim and the tire (fig. 4).
- The valve should be in an upright position (fig. 5).
- Center the tire before inflating it to the required pressure.
- Adjust the inflation pressure using a pressure gauge, e.g. the Schwalbe Airmax Pro. The permitted inflation pressure range is marked on the tire sidewall. Check the tire pressure at least once per month with an air gauge (fig. 6).

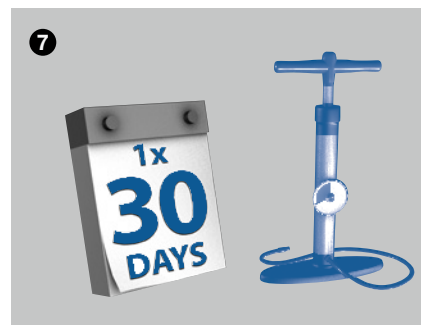
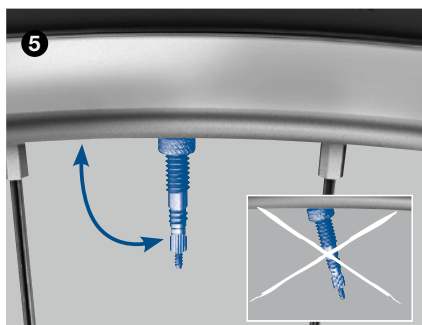
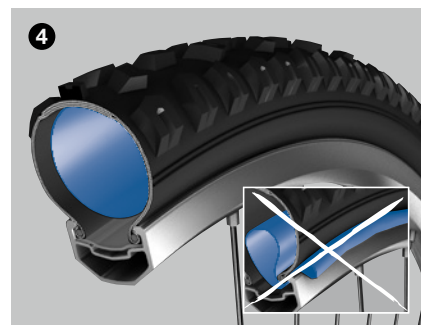
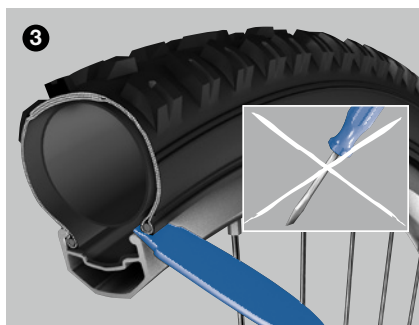
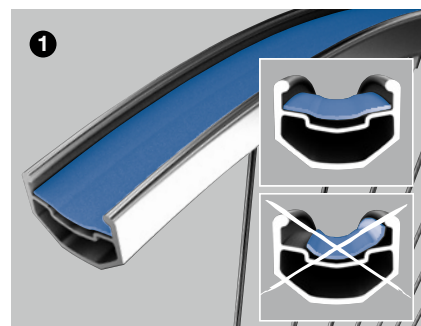



## Why is it sometimes so difficult to fit a tire?

Fitting difficulties often arise when the diameters of the rim and the tire do not match perfectly.

Rims may have a tolerance in diameter of +/- 0.5 mm (D1). In addition, the height of the rim flank also may have a tolerance of +/- 0.5 mm (G). This adds up to a complete tolerance of +/- 1.5 mm in the outer diameter (D2), or of +/- 4.7 mm in the outer circumference. This corresponds to a maximum possible circumferential difference of 9.4 mm between the largest and the smallest rim.

A tire must fit on both extremes. Because a safe fit must be ensured even on the smallest permissible rim diameter, the fitting and the proper centering of the tire on the largest permissible rim can prove quite difficult.

The circumferential tolerance of Schwalbe tires is  $\pm 1$  mm.

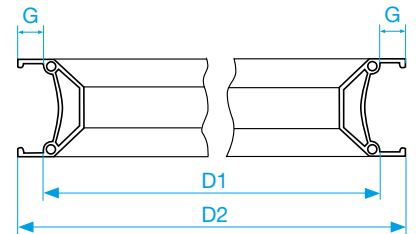

ETRTO tolerances of crotchet type rims

	DESIGNATION	TOLERANCE
D1	Bead seat diameter	$\pm 0,5$
G	Rim flank height	$\pm 0,5$
D2	Outer diameter of rim	$\pm 1,5$ 2x Tolerance G 1x Tolerance D1
U	Rim circumference	$\pm 4,71$ Tolerance D2xTT

## What can be done, if it is difficult to fit the tire on the rim?

It is always helpful to start the fitting opposite the valve and to finish it at the valve, as the tire bead to be mounted should lie in the rim well as far as possible.

Instead of pushing the tire with the thumb, it is often easier to roll the tire bead over the rim flange from the opposite side on.

Using tire levers helps a lot. Make sure the tire bead is not damaged during the fitting. Lever the tire in small sections and use the tire levers more often. Do not use metal tire levers.

Sometimes the fitting of the narrow versions of the Marathon Plus tire turns out to be particularly difficult. Due to the inherent stress of the tire, the tire slips repeatedly from the drop-center and it is extremely hard to pull the last piece of the tire over the rim flange. A helping hand holding the tire on the opposite side in the drop-center is very helpful. A cable tie or an old pedal strap could also serve as a helping hand.

The new Schwalbe tire lever is particularly helpful when fitting is difficult. You can hook it in on the rim and herewith fix the already mounted area of the tire bead. This will prevent the bead from slipping out while you lever the last section over the rim flange.



A cable tie as a helping hand



## What can be done, if the tire cannot be centered?

When the rim diameter is at maximum tolerance and the tire diameter is at minimum, it is difficult to get the tire beads onto the rim bead seat.

Solution: Slightly over-inflate the tire for a short time, or put soapy water onto the tire beads to make them slip into place more easily.

Our assembly fluid, Easy Fit, can be easily applied to the tire by use of the sponge applicator and without using extra tools or dirtying fingers. When inflating, the tire bead then glides easily into the right position on the rim. After approx. 10 minutes the liquid evaporates completely.

When the rim diameter is at minimum and the tire diameter at maximum, the tire cannot be seated properly regardless of the tire pressure. This situation can generally be addressed by centering the tire by hand at low inflation pressure. Move the tire with your thumb until the rim line is parallel to the rim all around the tire. Finish by inflating the tire fully.

Make sure it is parallel to the rim. Only then should you pump the tires up fully.



Easy Fit with practical sponge applicator



Rim line

## What should be observed for the fitting on hookless rims?

A crotchet type rim has become standard these days. This is a rim with rim flanges pointing inwards with their crotchet shaped ends. In addition, there are many rims on the market which are referred to as Westwood rims. These are often used on Dutch bicycles for example. These traditional rims do not have crotchets which hold the tire tight and centered. Furthermore, Westwood rims are made of steel and have a very smooth surface. These rims require special attention for fitting.

**Manual centering.** Before inflating the tire to its full pressure, make sure it is properly centered on the rim. The tire will not slip automatically into the correct position during inflating, as is the case with crotchet type rims. If the tire is not evenly positioned on the rim, it can come off the rim easily.

**Inflation pressure max. 4 bar.** These rims are not suitable for high pressure. In most cases you cannot max out the maximum inflation pressure of the tire on these rims. According to the ETRTO standard the inflation pressure is limited to five bar. We recommend that you allow for a greater safety margin and do not exceed four bar. You should also consider that these rims are not really suitable for narrow tires or heavy riders.

In addition, there are also state-of-the-art MTB carbon rims without crotchets on the market. According to our experiences so far, tire fitting on these rims does not cause any problems. The respective rim flange heights and material surfaces (friction) sufficiently prevent the tire from coming off.



crotchet type rim



classical Westwood rim

## How is a tubular tire fitted?

**Caution:** Tubular tires should be professionally fixed to rims using special contact cement!

As a test, first fit the tire without the contact cement (4-8). Check the valve length, using an extender if necessary. Recommendation: Fitting the tire on the rim beforehand using light pressure facilitates later permanent fixing.

**Tire:** Evenly coat the protective tape with a layer of contact cement (3) and let it dry for at least 6 hours.

**New rim:** Remove grease and if necessary roughen the rim well with fine sandpaper (1). Follow the rim manufacturer's instructions! Evenly apply a layer of contact cement to the rim and let it dry for at least 6 hours! (2)

**Used rim:** Examine the existing contact cement layer. An even and intact contact cement layer can be re-used. If the layer is very uneven, completely remove all remnants of the contact cement from the rim and apply new cement.

Apply a fresh layer of contact cement to the rim (2). Immediately fit the tire: Insert the valve. Pull the tire as firmly as possible, so that the final section of tire slips over the edge of the rim in an easy and controlled manner (4-7).

Slightly inflate the tire and center its position. The edge of the protective tape serves as orientation (8). Inflate to approx. 9 bar and push down on the whole circumference of the tire using your full bodyweight. Clean off any remnants of contact cement from the rim braking surface.

**Important:** Leave the assembly to rest under pressure for at least 24 hours! Check tires regularly. Never ride on tires with a damaged or loose protective tape.

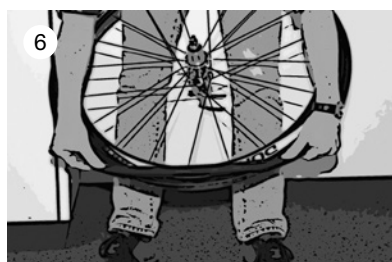
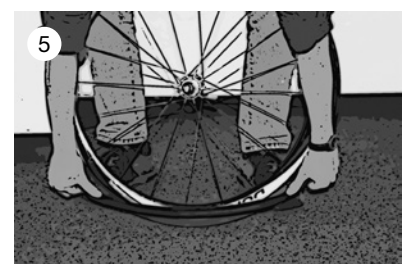

## Why is the inflation pressure of bicycle tires so important?

Only tires with sufficient inflation pressure can bear the weight of a bicycle. The following applies for the road: The higher the inflation pressure the lower the **rolling resistance** of the tire. The **susceptibility to punctures** is also lower with high pressure.

If the inflation pressure is continuously too low, premature tire **wear** is the result. Cracking of the sidewall is the typical consequence. Abrasion is also unnecessarily high.

On the other hand, an under-inflated tire absorbs road shocks better.

Wide tires are generally used at lower inflation pressure. The larger air volume is advantageous in that it absorbs road bumps and holes, but does not suffer from higher rolling resistance, less puncture protection or tire wear.

Tubeless tires can also be used at low inflation pressure.



Constant use at 1.5 bar



Constant use at 4.5 bar

## How often should inflation pressure be checked?

The inflation pressure should be checked and adjusted at least **once a month**. Even the best tubes constantly lose pressure as, contrary to car tires, the pressure required in bicycle tires is much higher and wall thickness much thinner. A pressure loss of 1 bar per month can be viewed as normal, but pressure loss will be much faster with high inflation pressures and much slower with low inflation pressures.

When using latex tubes, it is best to check and adjust the inflation pressure before every ride.

Use a **pressure gauge** to monitor the inflation pressure. The widespread thumb-test method is very inaccurate, as all tires will feel identically hard from a pressure of approx. 2 bar up. The thumb test is completely insufficient for Marathon Plus tires due to the special puncture belt.

Our air gauge Airmax Pro is suitable as a testing instrument. With the correct valve or a small adapter, inflation pressures can be tested and adjusted at a gas station. The purchase of a track pump with an air gauge is recommended for all active cyclists.



Inflation pressure check with the Airmax Pro.

## What is the correct inflation pressure for my tire?

It is impossible to make a general recommendation on inflation pressure for a specific bicycle or a particular tire. The “right” inflation pressure depends mainly on the load exerted on the tire. This weight is mainly influenced by the weight of the rider and any luggage. Contrary to a car, the vehicle weight is only a minor part of the total weight. In addition, there is a great diversity of individual preferences with regard to low rolling resistance or suspension comfort.

The permitted inflation pressure range is marked on the tire sidewall. The higher the inflation pressure, the lower the rolling resistance, the tire wear and the likelihood of a puncture. The lower the inflation pressure the higher are the comfort and grip that the tires provide.

The following list of inflation pressure recommendations can only provide a very general guide for three different rider weights

The more narrower the tire and the higher the overall load, the higher the necessary inflation pressure.

Tires with very small diameters (recumbent bike, folding bike) also require a higher pressure.

But the actual tire pressures should never be higher or lower than the maximum and minimum inflation pressures marked on the tire sidewall.



That's how it should look.  
The tire is hardly deformed under the weight of the rider.



That's how it shouldn't look.  
The inflation pressure is far too low here.

Tire width	Body weight		
	ca. 60 kg	ca. 85 kg	ca. 110 kg
25 mm	6.0 Bar	7.0 Bar	8.0 Bar
28 mm	5.5 Bar	6.5 Bar	7.5 Bar
32 mm	4.5 Bar	5.5 Bar	6.5 Bar
37 mm	4.0 Bar	5.0 Bar	6.0 Bar
40 mm	3.5 Bar	4.5 Bar	6.0 Bar
47 mm	3.0 Bar	4.0 Bar	5.0 Bar
50 mm	2.5 Bar	4.0 Bar	5.0 Bar
55 mm	2.0 Bar	3.0 Bar	4.0 Bar
60 mm	2.0 Bar	3.0 Bar	4.0 Bar

## What does a rim tape do?

The rim tape protects the tube from mechanical damage by spoke ends, metal burrs and holes in the rim.



SCHWALBE fabric rim tape.

## Which rim tape should I use?

An appropriate rim tape must completely and securely cover all spoke holes. Hollow section rims require the use of special rim tapes such as Schwalbe High Pressure or Schwalbe High Pressure fabric rim tape. Rubber rim tapes are not suitable for hollow section rims, because the inflated tube pushes them into the holes.

The rim tape must cover the entire rim base. If the rim tape is narrower than the rim base it can slide and expose the spoke holes.

Alternatively, an adhesive, fabric or tubeless rim tape can be used on all rims. Slipping cannot occur due to the heat resistant glue. The 18 mm wide tape should definitely be used for racing bicycle rims (13C, 14C). The 15 mm tape is recommended only for rims with a relatively wide drop-center which offers a contact area next to the spoke holes which is wide enough for the tape.

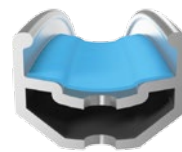

The complete rim bed is covered. The rim tape cannot move.



A rubber rim tape presses into the hole of a hollow section rim.

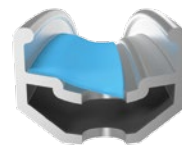

The rim tape is too narrow and does not cover the rim well.

## Why doesn't Schwalbe offer a 12 mm high pressure rim tape?

Some rims have a drop-center with a width of approx. 12 mm. It is intentional on our part not to provide a rim tape of 12 mm or less. Such a narrow tape would provide a very narrow and insecure cover.

Instead, we recommend using a wide tape that reaches from rim wall to rim wall. This may complicate the fitting process, but it provides the best option for a secure covering of all rim holes.

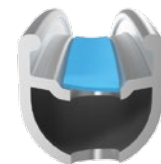

A 12 mm tape is too narrow and not safe.

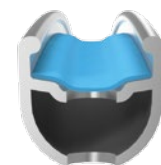

A wide tape that reaches from rim wall to rim wall is a more secure solution.

## What are the advantages of a tubeless tire?

Tubeless tires provide clear advantages in speed, comfort, grip and puncture protection. They avoid unnecessary friction between tires and tubes, which reduces the **rolling resistance** even more than with super light competition tires. Tubeless tires can be used with a lower inflation pressure without compromising performance. That brings clear advantages in **comfort** as well as clearly more **control** in critical situations and on bad surface trails. At the same time, tubeless systems provide a high **puncture protection**. The danger of blowouts is clearly reduced. A sudden loss of air pressure by burst tubes or valve tear off is excluded. What is more, tubeless systems function perfectly together with puncture protection liquids. Punctures are re-sealed within milliseconds.



## What do you need to fit a tire without tube?

- Schwalbe tubeless tires
  - Airtight tubeless wheel
  - (or tubeless easy tires and tubeless rim tape)
  - Tubeless valve
  - Sealing liquid (e.g. Schwalbe Doc Blue)
  - Assembly liquid (e.g. Schwalbe Easy Fit)
  - Track pump with air gauge
  - A rag
- You should be familiar with the specific fitting procedure.
- Otherwise you should leave the fitting to an expert.



## What do you have to keep in mind for the fitting?

Fit the tire as usual onto the rim. Be cautious when applying the tire levers. Important: Apply **assembly liquid** to both tire beads before inflating (1). Make sure the valve is between the beads when inflating (2). Start inflating with a **powerful burst of air** (track pump or compressor) (3). The tire engages audibly on the rim. Using the rim line, make sure the tire is properly in place (4).

Deflate the tire a little. Remove the valve core (valve key is supplied with Doc Blue) and fill in 60 ml of the **puncture protection liquid** Doc Blue (5). For road bike tubes 30 ml are enough.

- Strictly observe the indications regarding maximum inflation pressure of tire and rim!
- Do not use CO2 cartridges. CO2 has a negative effect on the puncture protection liquid.
- Be careful in general when using the sealing liquid. It easily causes stains on clothing or pieces of furniture.

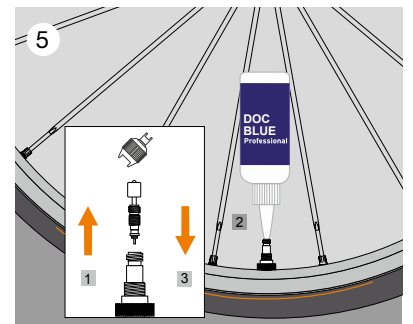
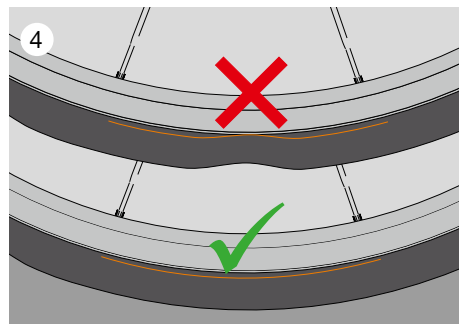
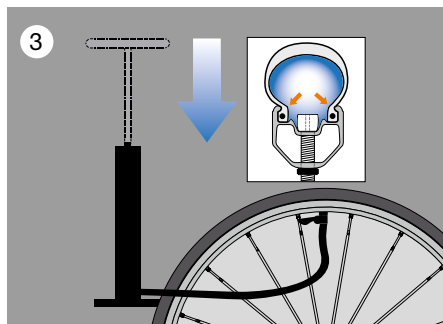
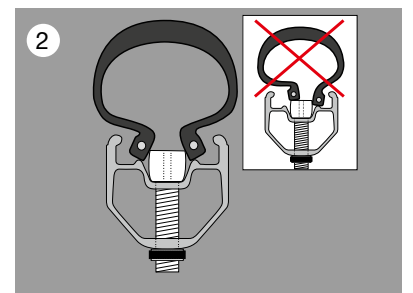

## Do I have to fill in the fluid through the valve?

No, you can fill the sealing liquid directly into the tire before mounting the second tire bead. A later filling through the valve has the advantage that your working process is cleaner, as the milk is only applied when the tire is already in its place on the rim. This is very convenient in particular with new tire/rim-combinations, where you don't know yet, whether fitting works without problems.

With common combinations, it is faster to fill in the sealant directly. If you use valves without replaceable valve cores, filling through the valve is impossible.





## Why do you need puncture protection liquid?

Real tubeless tires also function without sealing liquid. However, we recommend its use because the combination of tubeless tires and Doc Blue ensures superior puncture resistance. The sealing liquid has no negative influence on rolling resistance.

Tubeless Easy tires do not have an absolutely dense butyl coating. They require Doc Blue to ensure permanent tightness.



## What can be the reason, if the tire cannot be inflated?

Be sure to use the fitting fluid! Due to the lubricating film between tire and rim, the tire is positioned much more evenly. In an emergency it is possible to get by with soapy water.

Both tire beads must be positioned either side of the valve.

When inflating for the first time, it may also be helpful to remove the valve core in order to increase the air flow.

In very stubborn cases, use a compressor instead of a track pump.

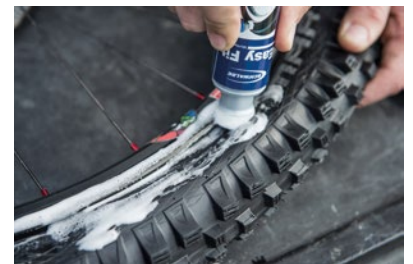

## Further reasons for what can go wrong

Leaks can of course happen at the valve or around the rim. In order to determine the leaks, it is necessary to completely immerse the wheel in water. If there are leaks, air is emitting at the valve and/or spoke nipples. This may take a while, because the pressure has to build up in the rim cavity first. Often the problem is in the valve area. Possible remedy: Tighten the valve nut, clean and deburr the contact area valve/rim and replace the valve. If all of this does not help, the cause of the leak may be a defect in the rim joint or a crack in the rim base.

## Is it possible to retrofit normal wheels for the fitting of tubeless tires?

With the **tubeless rim tape** and the **tubeless valve** from Schwalbe it is possible to seal standard wheels and to make them fit for tubeless use. It is then no longer necessary to invest in new, more expensive wheels, if you want to change.

The Schwalbe Tubeless rim tape is absolutely high pressure and heat resistant. One ply of rim tape is sufficient. Even in the case of a road bike. The Schwalbe tubeless rim tape is available in 6 different widths from 19 to 29 mm.

The Tubeless valve is made of aluminum and very light. The conical valve foot ensures universal fitting on almost all rims. The valve foot is reinforced with metal to prevent it from moving accidentally into the valve hole. The valve nut has an anti-twist protection to prevent the valve from coming loose unintentionally during the ride. To ensure that the tubeless conversion also works on deep-rim profiles, our product range also includes threaded valve extensions.



Schwalbe Tubeless rim tape and valves.  
It is no longer necessary to invest in new, expensive wheels.

## Which wheels are suitable for the conversion?

- You should only use wheels which are expressly approved by the manufacturer for a tubeless conversion.

This is particularly important in the case of the high-pressure system road bike. This will ensure that the rim will bear the specific loads in the tubeless use and that the tire fits safely on the rim. The complete Spline® series from DT Swiss for example has been tested and approved for the tubeless conversion.

A conversion is often impossible in the case of very narrow rims (13C), rather low-priced, not welded or double eyelet rims. In these cases it is mostly impossible to ensure an airtight sealing of the rims with the rim tape.



## What do you have to keep in mind for the tubeless conversion?

The rim base must be absolutely clean and even. If necessary, remove old glue and grease residues with brake cleaner.

Make sure all spoke holes are fully covered by the **rim tape**. The best option would be, if the rim tape covered the complete rim base. In most cases, the rim tape is suitable when it is 2-4 mm wider than the rim width.

Pull the rim tape forcefully before applying it, to avoid air bubbles. Let the tape end overlap by approx. 5-10 cm. We recommend that the overlapping is not in the valve area.

Simply press the tubeless valve with the pointed end through the rim tape.

Even though not very popular among road racers, a valve nut is absolutely necessary for the tubeless use in order to fix the valve safely on the rim. The valve nut on the Schwalbe Tubeless valve has an integrated anti-twist protection. This valve makes inflating a little difficult, but avoids an unintentional opening of the valve during the ride.

Inflating converted rims with a track pump is often impossible. You should expect that you need a compressor when fitting the tire for the first time.

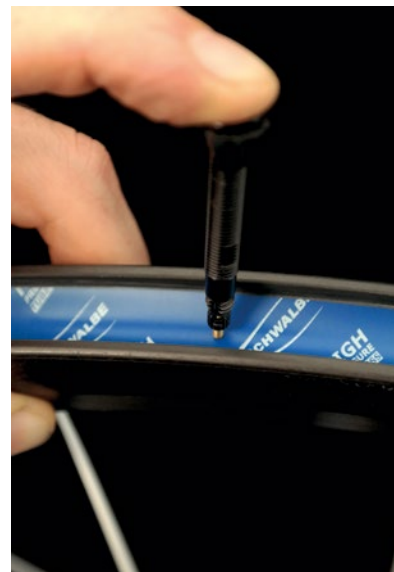

## How often do I have to refill or replace the sealing liquid?

Refilling the sealing liquid is only necessary to maintain the protection against punctures. Schwalbe Doc Blue remains active as preventive puncture protection for approx. 2-7 months or approx. 2000 km. After this period it dries out and turns into a rubber film or separates into the individual components (latex and liquid).

By using a needle you can easily test, whether the sealing liquid is still functioning. Simply pierce the running surface and let the tire rotate. Refill sealing liquid if the hole does not seal immediately. The "test hole" is repaired with the new sealing liquid.

## What to do in case of a puncture

While riding punctures are automatically sealed and repaired by Doc Blue. Sealing liquid cannot help with large punctures caused by cuts or snake-bites. In these kinds of cases a **spare tube** is always the best remedy. Remove the tubeless valve and wipe the sealing liquid out of the tire first.

## Do you need special tires for e-bikes?

For standard pedelecs with pedal assistance up to 25 km/h no specific tires are stipulated by the legislators. But the loads and average speeds of these bicycles are also higher than in the case of normal bicycles. We therefore recommend only certain tires as “E-Bike Ready 25”. Primarily, these are the tires of the Marathon and Energizer series as well as the comfort tires Big Apple and Big Ben.



## What to bear in mind with speed e-bikes

For speed e-bikes you need a special approval for the tire equipment. Tires with ECE-R75 authorization valid throughout the European Union are the simplest solution in this case. All of our Energizer tires have the mark of conformity and are approved for vehicles up to 50 km/h.



Table of all tires with ECE

## There are some Marathon sizes with the ECE-R75 mark of conformity. What are the differences between Energizer and Marathon?

The rubber compound: Marathon tires are particularly known for their extremely high mileage. The mileage of the Energizer models is comparable, but their main feature is their grip and hence the safety at high cornering speeds.

## Why does Schwalbe not offer winter tires without spikes?

Very simple: Because Schwalbe considers this as the only safe option to cycle in snow and ice.

Of course it would be nice to cycle without the permanent noise of the spikes. On a car, winter tires with sipe technology and a compound which provides grip are a good idea. However, the situation on a bicycle is completely different. You only ride on two tires and when you start slipping on an icy road, you fall directly on your face.

Our product range comprises plenty of tires with grip and coarse tread which offer good services on wet and cold roads, muddy forest tracks and even on firm snow. Whoever looks for such a tire makes a good choice with tires, such as **Smart Sam** or **Marathon Mondial**. But whoever wants to ride safely on an icy road, will have to choose tires with spikes.



Schwalbe Spike Tires  
Ice Spiker Pro // Marathon Winter // Winter



## Things you should know about spiked tires

**Can you ride with spikes also on normal roads?** No problem at all. If, however, snow is rather seldom and the roads are mainly free, the running noises will soon become irritating.

**And you don't slip away?** No. The spikes dig themselves very well into normal asphalt roads. Even fast curves are unproblematic.

**Are spikes forbidden?** On bicycle tires spikes are no problem. In some countries, spikes are forbidden only for automotive vehicles, as they damage the roads. However, speed e-bikes are considered as automotive vehicles.

**Is it necessary to run in tires?** To ensure the durable hold of the spikes, the tires should be run in approx. 40 km on asphalt roads. Avoid forceful acceleration and braking during this period of time.

**How long is the service life of spikes?** All Schwalbe spikes have a core made of extremely wear resistant carbide (tungsten carbide). With these spikes you can ride a few thousand kilometers. The fact that the corners are rounded by grinding and the spikes are pressed deeper into the material is normal.

**Individual spikes got lost.** Can they be replaced? Yes, replacement spike kits incl. tools can be ordered from Schwalbe.

**When do tires reach their limits?** In deep snow even tires with spikes are no longer a help.

**In my region, snow is seldom. How can I make good use of tires with spikes?** The best option is to fit the tires on a second bicycle. In the morning you decide which bicycle is suitable for the respective weather. On icy roads it is a great feeling to have full control on tires with spikes, even when the cars drive very slowly.



## What is a balloonbike?

We define a balloonbike as an everyday or touring bicycle with particularly **large volume tires**. With tires widths between 50 and 60 mm it is possible to build a very **comfortable bicycle** without elaborate suspension technology. The voluminous air cushion of the tires is used as natural suspension. With approx. 2 bar a balloonbike rolls wonderfully easily and with a full suspension effect. A standard tire at a width of 37 mm must be inflated hard to 4 bar to achieve a comparably good rolling performance.

With **Big Apple** the trend towards wider tires started in 2001. They were meant as an alternative for the full suspension trekking bikes which were very popular in these days. Suitable bicycles for these wide tires were not yet available in these former days. However, the concept was convincing and a large number of bicycles were then developed especially for this concept.

As early as in the beginning of the 20th century, balloonbikes had already been very popular. They were designed to compensate for the worst unevenness's on the many poor roads. But in these days tire technology was not very developed and the tires were heavy and sluggish. In contrast to that a Big Apple is clearly lighter and smoother.



## What are the advantages with regard to full suspension?

In tests the German Sport University Cologne certified balloonbikes a similar comfort as a full suspension bike. On a test course approx. 25 percent less acceleration at the lumbar spine was measured with Big Apple tire equipment (60-622, 2 bar) than on the same bicycle with standard tire equipment. Compared to that a full-suspension bike could reduce the acceleration at the lumbar spine by 33 percent.

In contrast to that the balloonbike is clearly cheaper, lighter and requires less maintenance. In addition, the "tire suspension" responds well, an advantage which is more important in everyday life than a long suspension travel. On a cobblestone test course the Big Apple tire equipment could reduce the vibration at the handlebars by approx. 36 percent, whereas two trekking suspension forks tested in parallel hardly responded to the inconvenient vibrations.

Of course, a balloonbike can also be combined with other suspension systems. A high-quality conventional suspension can further increase the suspension comfort, as certain damping effects complement one another.

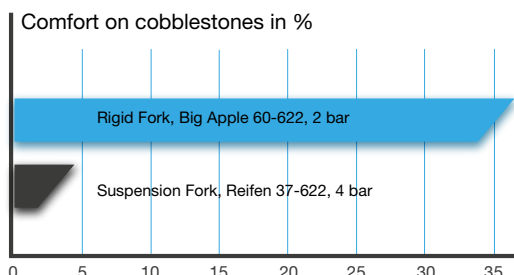
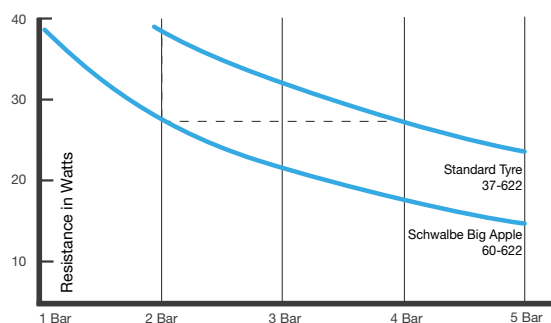

## What is the intended use of a balloonbike?

Balloonbikes are meant to make cycling more comfortable in everyday life. On poor cycle lanes or coarse cobbles, the “tire suspension” principle works clearly better than a conventional suspension system.

If the regular comfort of your inflated tires is enough for you, you do not need a balloonbike. Especially ambitious cyclists will not necessarily be happy with them. Road racers for example ride very narrow tires, as they are lighter and allow faster acceleration. However, during a steady ride and constant speeds around 20 km/h wide tires roll more easily and are much more comfortable.

The suspension travel of the tire is, as a matter of fact, limited. Balloonbikes are certainly neither suitable as a substitute for full suspension mountain bikes.



## Can I fit wide tires on a normal bicycle?

This is, of course, possible in general. However, most of today’s normal trekking or city bikes will not offer enough clearance for a balloon tire. Please observe the following points, when you intend to assemble a balloonbike on your own.

**Fitting dimensions.** The frame or the fork must offer enough clearance for the tire. The exact dimensions of our extra wide tires are given in chapter “Tire Dimensions”. In most cases the tire height is of higher importance than the tire width.

**Bottom bracket height.** Using 60 mm tire equipment instead of the usual 37 mm tire equipment increases the overall height of the bicycle by two centimeters. For comfortable ground contact for the feet the bottom bracket should be lowered. Caution: Bicycles with lowered bottom bracket should not be fitted with narrow tires for safety reasons. The pedals could touch the ground in a bend.

**Foot space.** The feet should not touch the front wheel during pedaling. It is difficult in general to observe these conditions with large 28 inch wheels and small frame sizes. The wide tires will enlarge the outer circumference of the wheel. It is therefore easier to design a balloonbike at 26 or 27.5 inches for small to average size persons.

**Steering geometry.** Do not use a frame designed to be used with a suspension fork. As a rigid fork is significantly shorter, the steering characteristics could change unpleasantly.

**Mudguard.** The mudguard must provide enough space for the wide tires. Especially for the 60 mm BIG APPLE, SKS offer the extra wide mudguard P65.

**Brake.** If you have rim brakes, make sure they offer enough clearance for tires and mudguard. In some V-brakes the brake arms are not long enough.



## Is there a connection between tires and a wobble?

The unpleasant wobble, also referred to as **shimmy effect**, usually occurs, when the natural frequencies of different bicycle components (such as frame, fork, tires...) overlap and mutually reinforce each other. In most cases it only occurs in a certain speed range.

We are facing that phenomenon in most cases when it occurs after a tire change for the first time. Nevertheless, it is not the tire which can be made responsible for this problem. It is simply an unfavorable interaction of different components. The same tire used on many other bicycles will not cause any problems.

By tendency, the problem occurs more frequently, the larger the volume and the heavier the tires. The same applies to an unfavorable distribution of the baggage and a less stiff bicycle frame. But there is no bicycle which is really immune to that. We have even experienced this phenomenon with extremely stiff bicycle frames.

To remedy the problem, you have to actually “upset” the entire system. It is absolutely possible that the shimmy effect can be remedied by choosing another tire model or already by modifying the inflation pressure only. Replacing the frame or the fork would probably also help, but replacing these parts is not so easy.

## Why do some tires leave discolorations on plastic floor coverings?

Some rubber compounds have a strong predisposition to discolor their surrounding area. A long-term, persistent contact with other rubber or plastic materials will make certain color components migrate into the contact material.

If a bicycle is left standing for example for a long period of time on a plastic or painted wooden floor, it may happen that permanent discolorations will occur in the contact area of the tire. A prolonged contact (e.g. when in stock or during transport) with multi-colored tires, plastic materials or painted surfaces can be problematic, as well.

Especially high-performance rubber compounds are often such “staining” compounds. You can actually formulate rubber compounds in a way that this staining effect does not occur. And this is in fact the case with most Schwalbe rubber compounds. But if we want to achieve the very best properties with regard to rolling resistance and grip, this staining effect as a side effect unfortunately cannot be avoided completely.

For exactly this reason you very often see high-end tires with a discolored logo in the tire label. A discolored logo especially on an expensive tire is not really nice, of course, but at the same time it demonstrates that this tire was uncompromisingly optimized for performance.



Discolored Label



## Does it make any sense to deflate tires for transport by air?

This regulation is unfortunately required insistently at many airports. From our point of view it makes little sense.

Pressure compensation in the cargo hold of a passenger plane is standard today. But even in case of a transport in a space without pressure compensation, the change of the inflation pressure at a height of 10000 m / 32800 feet would be minimal compared to the pressures a tire must withstand in any case. In a completely air-evacuated space, the pressure would be exactly 1 bar higher than under normal atmospheric conditions.

On the other hand, the risk of damage is much greater for tubes or rims when transporting the bicycle with flat tires. For this reason we recommend that you keep the tires inflated during transport by plane. We are, however, also aware of the fact that even convincing arguments will be of little help against the regulations of an airport company.

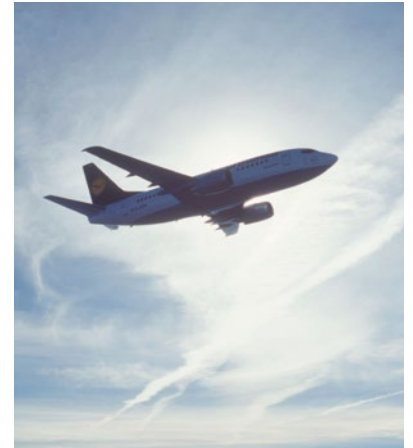

At Lufthansa there is no longer this illogical thinking

## Who actually invented the bicycle tire?

In this case, it's not made in Switzerland. But it's not made by Schwalbe either, as the bicycle tire is much older than our brand. It was mainly thanks to two gentlemen from the 19th century: Charles Goodyear and John Boyd Dunlop.

In 1839 the American Charles Goodyear discovered more or less accidentally the vulcanization process and manufactured the first rubber. 50 years later the British veterinarian John Boyd Dunlop invented pneumatic tires which made cycling much more comfortable. Prior to that "boneshaker" had been another name for a bicycle.

As early as 1845 a Scotsman named Thomson had already applied for a patent for a pneumatic tire. But due to the fact that bicycles were still little known, he did not find anyone interested in his idea.

The economic breakthrough came with the French Michelin brothers who developed a pneumatic tire with separate tube in 1889. In 1904 the first tire with tread was built by Continental.

The history of Schwalbe tires started in 1973. Up to that time bicycle tires were hardly a high-quality product. This is what Ralf Bohle, the founder of Schwalbe, wanted to change. He specialized solely on bicycle tires. Since these days, Schwalbe stands for numerous innovations, such as the Marathon series, the redevelopment of the balloon tire equipment, the invention of the Flat-less® tire, the further development of the tubeless technology and much more.



Charles Goodyear (1800 - 1860)



John Boyd Dunlop (1840 - 1921)

## Where does the name Schwalbe come from?

In 1973 Ralf Bohle imported bicycle tires from Korea to Germany for the first time. These were called Swallow. In these days, Germany was the biggest and most important market. For this reason "swallow" was translated into German, i.e. Schwalbe.

In Korea the tiny little bird is a traditional sign of good luck. For us it symbolizes that cycling is a wonderful way of moving: fast, light-hearted, with confidence, naturally and free.

Swallow tires are in fact still available today. Our partner company HungA distributes them mainly in Asian countries. The Schwalbe brand is, however, a name which is more well-known all over the world.



**Schwalbe.**



---

## Notice



Schwalbe Headquarters  
Ralf Bohle GmbH · 51580 Reichshof · Germany  
Tel. +49 2265 1090 · [www.schwalbe.com](http://www.schwalbe.com)

Schwalbe North America · Ferndale, WA  
Tel. +1 888 700 5860 · [www.schwalbetires.com](http://www.schwalbetires.com)

Schwalbe Tyres UK Ltd. · Shropshire TF1 7ET  
Tel. +44 1952 602680 · [www.schwalbe.co.uk](http://www.schwalbe.co.uk)

Schwalbe France SARL · 38510 Morestel  
Tel. +33 4 74805842 · [www.schwalbe.com](http://www.schwalbe.com)

Schwalbe Italia s.r.l. · 20864 Agrate Brianza (MI)  
Tel. +39 039 6058078 · [www.schwalbe.it](http://www.schwalbe.it)

Schwalbe Nederland b.v. · 2132 PX Hoofddorp  
Tel. +31 23 5555265 · [www.schwalbe.nl](http://www.schwalbe.nl)



Like us on Facebook  
[facebook.com/schwalbetires](https://facebook.com/schwalbetires)